

ASME B31.3 Process Piping Guide

RECORD OF REVISIONS (AS REF-3)

0	9/17/2014	Initial issue. Previously Chapter 17 Section D20-B31.3-G; minor administrative changes.	Ari Ben Swartz, <i>ES-EPD</i>	Mel Burnett, <i>ES-DO</i>
---	-----------	---	----------------------------------	------------------------------

DOCUMENT HISTORY

Rev	Date	Description	POC	OIC
0	11/5/02	Initial issue in Section 200 of LANL Engineering Manual Mechanical Chapter. Based on SRS guide.	Tobin Oruch, <i>FWO-SEM</i>	Kurt Beckman, <i>FWO-SEM</i>
1	6/9/04	Administrative changes to become ESM Mechanical Chapter Section D20 Appendix A.	Charles DuPrè, <i>FWO-DECS</i>	Gurinder Grewal, <i>FWO-DO</i>
2	3/10/09	Administrative changes to become ESM Pressure Safety Chapter 17 Section D20-B31.3-G	Charles DuPrè, <i>ES-DE</i>	Kirk Christensen, <i>CENG-OFF</i>

TABLE OF CONTENTS

PURPOSE4

B31.3 INTRODUCTION.....4

I - SCOPE AND DEFINITIONS5

II - DESIGN6

III - MATERIALS16

IV -STANDARDS FOR PIPING COMPONENTS16

V - FABRICATION, ASSEMBLY AND ERECTION16

VI - INSPECTION, EXAMINATION AND TESTING21

APPENDIX A – PIPING SPECIFICATIONS26

APPENDIX B – FLUID SERVICE SHEETS80

APPENDIX C – MATERIALS SELECTION101

APPENDIX D – VALVE SELECTION GUIDE.....106

APPENDIX E – FLANGED CONNECTIONS.....119

APPENDIX F – ALIGNMENT FIT-UP TOLERANCES.....127

APPENDIX G – COMPONENT IDENTIFICATION132

APPENDIX H – LEAK/PRESSURE TESTING.....140

APPENDIX I – STRESS ANALYSIS145

APPENDIX J – FILLET WELD SIZES.....151

APPENDIX K – CLEANING CARBON AND STAINLESS STEEL PIPE.....156

APPENDIX L – BURIED PROCESS PIPE162

APPENDIX M – MITERED JOINTS163

APPENDIX N – BRANCH CONNECTIONS.....165

APPENDIX O - SAFETY CLASS PIPING SYSTEMS167

APPENDIX P – REPAIRS, MODIFICATIONS AND MAINTENANCE168

APPENDIX Q - APPLICATION OF ASME B31.3 TO RADIOACTIVE FLUIDS.....170

APPENDIX R – DEFINITION OF ACRONYMS.....171

PURPOSE

This Guide provides information for the proper application of the [ASME B31.3 Code "Process Piping."](#) It was last updated for the 2002 edition. ASME B31.3 applies to process piping and tubing systems at Los Alamos National Laboratory (LANL). This Guide also contains ASME B31.1 and AWWA compliant Piping Specifications. Guide users are responsible for compliance with all aspects of the applicable Code. This Guide addresses only B31.3, however this guidance is typical of the requirements of other piping Codes.

The information contained in this Guide provides clarification to the Code text, additional information not contained in ASME B31.3, and design input specific to LANL. **This Guide is not to be used as a stand-alone document.** This Guide is formatted to be used in conjunction with ASME B31.3, by following the same section numbering as B31.3 Code. Appendix references herein are to this Guide, not B31.3 or the ESM, unless otherwise noted.

A user who desires clarifications on the application of piping related Codes and Standards should contact the LANL Engineering Standards Pressure Safety Point-of-Contact.

In the event of a contradiction between this and other ESM material, the other material shall have priority.

B31.3 INTRODUCTION

The Introduction to ASME B31.3 states "It is the owner's [Design Authority] responsibility to determine which Code Section is most applicable to the piping installation."

The other ASME B31 Code Sections and other common National Consensus Codes are listed in Table 1. Building and plumbing Codes as required by state and local jurisdictional requirements apply to potable water, and for sewer and drain systems that do not have a process function.

Table 1- National Consensus Codes and Standards for Piping

Organization	ID	Title
ASME	B31.1	Power Piping
ASME	B31.4	Liquid Petroleum Transportation Piping Systems
ASME	B31.5	Refrigeration Piping
ASME	B31.8	Gas Transmission and Distribution Piping Systems
ASME	B31.9	Building Services Piping
ASME	B31.11	Slurry Transportation Piping Systems
ANSI/AGA	Z223.1	National Fuel Gas Code (same as NFPA 54)
AWWA	C 100	Cast-Iron Pipe, Fittings
AWWA	C 200	Steel Pipe
AWWA	C 300	Concrete Pipe
AWWA	C 400	Asbestos Cement Pipe
AWWA	C 500	Valves and Hydrants
AWWA	C 600	Pipe Laying
AWWA	C 900	PVC Pressure Pipe
AWWA	M9	Concrete Pressure Pipe
AWWA	M11	Steel Pipe-Guide for Design and Installation
NFPA	Multiple	Fire Protection Systems

Guidance supplementing the Code is necessary because the Code provides no explicit rules for functional design, material compatibility with fluid and environment (erosion/corrosion protection, radiation

Section REF References

Rev. 0, 9/17/2014

REF-3 ASME B31.3 Process Piping Guide

effects, etc.), layout, serviceability, steam tracing, grounding, valve and component selections, design of pipe supports, material traceability, gasket selection, as-built tolerances, insulation, cleaning for special process, etc. Also, for certain services some options available through B31.3 must be excluded, made more stringent or supplemented by the designer.

Warning: The original and continued safe operation of a piping system depends on the competent application of codes and standards.

The **Owner and Designer are responsible** for compliance with the personnel and process qualification requirements of the codes and standards.

In particular, the application of ASME B31.3 requires compliance with the **Inspector** qualification requirements of ASME B31.3 Section VI for all fluid services (safety or non-safety related).

I - SCOPE AND DEFINITIONS

300(b) - Responsibilities

The following responsibilities are applicable at LANL:

- 1) Owner - The Owner is the Design Authority. See Acronyms and Definitions sections in ESM Chapter 1 Section Z10 and Chapter 17, Pressure Safety.
- 2) Designer - The Designer is the Design Agency.
- 3) One of the signoffs on a piping work package must reflect an "**Owner's Inspector**" review. This means:

The person signing must have the minimum experience of 340.4(b), and

The person signing must have verified, to the extent necessary, that code and engineering design requirements for examination and testing are met (341.4.1).

300(c) - Intent of the Code

- 1) The code addresses the structural integrity of the piping system. The designer is responsible for all other aspects of the design including the functional design of the system.
- 2) Recommendations for applying ASME B31.3 Code to repairs, modifications, and maintenance are provided in Appendix P.
- 3) Appendix B provides Fluid Service Sheets to assist in selection of materials for compatibility with common fluid services. Historical TA-55 Specification 4401-J-1 contains material recommendations for PF-4.

300.1.1 - Content and Coverage

- 1) ASME B31.3 may be applied to Radioactive Fluid Services. See Appendix Q.
- 2) Transfer lines between facilities (such as waste or steam transfer lines) that support processing functions may be designed and constructed to ASME B31.3.

300.1.3 - Exclusions

- 1) Note that paragraph 300.1.3 (a) does not exclude vacuum systems.

REF-3 ASME B31.3 Process Piping Guide

- 2) Radioactive fluids should not be excluded from ASME B31.3 Scope. See Appendix Q.
- 3) For fire protection, refer to the [NFPA Codes](#) and [ESM Chapter 2](#).

300.2 - Definitions

- 1) Category M Fluid Service is recommended for safety class piping systems. See Appendix O.
- 2) Radioactive fluids should not be classified as Category D Fluid Service. See Appendix Q.
- 3) The Owner's Inspector is responsible for verifying the piping installation to the extent necessary to be satisfied that it conforms to all applicable examination requirements of the Code and of the Engineering Design. LANL Owner's Inspector(s) are designated by the Construction Engineering
- 4) Normal fluid service Piping Specifications (Appendix A) may be used in Category D fluid service.
- 5) Examiner - The person(s) certified by the employer as qualified to perform the quality control functions specified in ASME B31.3. The LANL ESM Chapter 13 specifies how NDE is processed at LANL.

II – DESIGN

301.1 - General

Of all the design considerations listed in 301, only pressure rating is covered in the Piping Specifications in Appendix A. The Piping Specifications provide materials, fittings, and fasteners, which meet the pressure design requirements of B31.3. The designer must address all design conditions.

301.2.2 - Required Pressure Containment or Relief

Piping systems are designed to either safely contain or relieve the maximum pressure that can be imposed. Plant fires can present a safety concern for certain piping systems. The installation of pressure relief devices should be considered for liquid systems greater than 6" ID that can have isolated fluid.

Helpful information is available in ESM Chapter 17.

301.5.1 - Impact

Piping systems must be designed to withstand anticipated fluid transients (waterhammers, pressure surges, etc.). These are the transients expected to occur during normal operation of the system. Piping systems cannot be designed for unanticipated transients. These are the transients that can occur if the system is not properly operated. Unanticipated transients must be eliminated by design (layout) and appropriate startup and operating procedures.

REF-3 ASME B31.3 Process Piping Guide

301.5.2/3- Wind and Earthquake

The applicable wind and earthquake requirements are defined [LANL Engineering Standards Manual Structural Chapter 5](#).

301.5.4 - Vibration

New designs, modifications, repairs, replacements, should be visually inspected at startup to verify that vibration is not excessive. The rules of [ASME "Standards and Guides for Operation and Maintenance of Nuclear Power Plants" OM-S/G, Part 3](#), can be used for guidance. The ASME OM document provides a methodology to evaluate vibration using high cycle fatigue analysis and can be applied to any piping system.

301.8 - Effects of Support, Anchor, and Terminal Movements

Soil settlement can adversely affect the integrity of a piping system and the flow in a sloped line. When proper slope is required to maintain flow in an underground piping system, soil settlements need to be evaluated in the design of the piping system.

302.2.1 - Listed Components Having Established Ratings

Tables 326.1, A326.1, and K326.1 provide a listing of standards and specifications that have been accepted by the Code. Some of these standards provide established pressure/temperature ratings for components (e.g., ASME B16.5). The components may be used in piping systems within the specified ratings without additional analysis. If these components are used outside established ratings additional analysis is required.

302.2.2- Listed Components Not Having Specific Ratings

Some standards and specifications provided in Tables 326.1, A326.1, and K326.1 base pressure/temperature ratings on equivalent schedule (wall thickness) of straight seamless piping less mill tolerance (e.g., ASME B16.11). The ratings of these components are addressed in the piping specifications provided in Appendix A. If these components are used outside the limits established in the piping specification additional analysis and documentation must be provided.

302.2.3 - Unlisted Components

The ASME B31.3 Code defines unlisted components as components not in Tables 326.1, A326.1, or K326.1. Unlisted components can have pressure ratings but the owner and/or the designer has the responsibility to verify that the design, materials, fabrication, examination, and testing of the component meet the requirements of ASME B31.3. Unlisted components are generally categorized as one of the following:

- ☐ Components built to Unlisted Published Standards,
- ☐ Components built to Manufacturers Standards, or
- ☐ Components built to Site Standards or Engineering Design.

Each of these categories is addressed below.

COMPONENTS BUILT TO UNLISTED PUBLISHED NATIONAL STANDARDS

Components built to other published National Standards may be used provided that the design, material, fabrication, examination, and testing have been verified to meet the

REF-3 ASME B31.3 Process Piping Guide

requirements of ASME B31.3. The Code states that the pressure design must meet the requirements of paragraph 304 of B31.3. The rules described below for components fabricated at LANL should be followed when published National Standards are not acceptable.

COMPONENTS BUILT TO MANUFACTURERS STANDARDS

Components built to Manufacturers Standards have not been established by a consensus body and require a more detailed review than components built to Published National Standards. Many manufacturers build components for application in ASME B31.3 piping systems therefore, evaluations of the design, materials, fabrication, examination, and testing to B31.3 requirements is less difficult.

The pressure/temperature design of the component should provide the same safety margins as the Code. When evaluating these components the manufacturers should be contacted to determine what documentation is available for the components. Suppliers or distributors of the component may not understand the Code and may not be helpful in resolution of the issues associated with qualifications of the unlisted component. Manufacturers are the best source of information. If the manufacturer's documentation is not acceptable, the owner and designer must perform the component qualification. The rules described below for components fabricated at LANL should be followed when Manufacturers Standards are not acceptable. Another alternative is to select a different manufacturer to supply components that meet B31.3 requirements.

COMPONENTS BUILT TO SITE STANDARDS

Piping components that form part of the pressure boundary of a piping system, that are fabricated at LANL require qualification to the requirements of the B31.3 Code. The pressure design of these components is specified in paragraph 304.7.2 of the Code. The Code requires that calculations be performed to support the design of these components. These calculations must be consistent with the design criteria of the Code and must consider all applicable ambient and dynamic loads (ref. paragraph. 301.4 through 301.11). The Code also requires that the calculations be substantiated by one of the following methods:

- ☐ Extensive successful service of the component under comparable conditions including loading, environment and fabrication of like materials,
- ☐ Experimental stress analysis to code requirements,
- ☐ Proof testing to code requirements, or
- ☐ Detailed stress analysis to ASME B&PV Code Section VIII, Div. 2.

EVALUATION OF COMPONENTS FOR PRESSURE/TEMPERATURE RATINGS

The preceding describes actions to meet necessary Code requirements for unlisted components. All piping components in a B31.3 system must meet the minimum Code requirements for design, materials, fabrication, examination, and testing. The following guidance is provided for review of these areas when evaluating an unlisted component.

DESIGN

The rules in B31.3 address the pressure design of components in paragraph 304. The rules and equation in paragraph 304 can be applied to simple shapes, such as cylinders and other common piping geometry. Equations and rules for additional shapes can be found in the ASME B&PV Code Section VIII. The design methodology in Section VIII is acceptable for unlisted component analysis in B31.3. Additional methods used to evaluate unlisted components include the use of equations in "Roark's Formulas for Stress and Strain". The use of all these equations requires that the components be

idealized into bounding shapes for which the equation is valid. Manufacturers generally use simple shapes in the design of components, to minimize fabrication costs.

Design qualification of unlisted components can also be accomplished by comparison to listed components with established pressure/temperature ratings. The comparison involves a review of the wall thicknesses and geometry to demonstrate that the unlisted component is bounded by a component with an established pressure rating.

MATERIAL

Typically, unlisted components are fabricated from B31.3 listed materials. However, when the materials are not listed by the Code, the material must be qualified in accordance with the requirements of the Code. Reviewing the material of an unlisted component is done to ensure a specified minimum allowable stress at the design temperature. The sources for allowable stress values include the ASME B31 Codes of Pressure Piping and the ASME B&PV Code Section II. B&PV Code Cases should also be reviewed for allowable stresses for specific materials. The material should also be reviewed for susceptibility to degradation mechanisms associated with the service conditions, including a review of brittle fracture.

FABRICATION

The processes used to fabricate unlisted components must also be reviewed for Code compliance. Some fabrication processes can cause gross or local wall thinning. If wall thinning is possible, thinning should be accounted for when the nominal thickness is specified. Additional fabrication allowances should be added to the required thickness to account for manufacturing processes. Examples of wall thinning include the 12½% mill tolerance that is applied to all piping and the allowances for wall thinning due to pipe bending and threading. If welding is used, the welders and welding procedure must be qualified to ASME Section IX. If bolting is used, torquing procedures should be consistent with Appendix E.

EXAMINATIONS

Unlisted components fabricated at LANL must be examined in accordance with the Code. Components that are mass-produced to manufacturer's standards may have statistical quality control methods applied. When components are built to manufacturer's standards that require examinations, the standard should be reviewed to ensure that the extent of required examination and acceptance criteria meet the Code requirements for the specified fluid service category. When manufacturers do not specify examination requirements, the design should be reviewed to ensure that adequate margin (i.e., wall thickness) exists above the minimum design requirements to address the lack of examination. To review this aspect, the Basic Casting Quality Factors, Table A-1A of B31.3, the Basic Quality Factors for Longitudinal Weld Joints, Table A-1B, and the Joint Efficiencies, UW-12 B&PV Section VIII, can be used as guidance in determining an adequate wall thickness for castings or components joined by welding.

TESTING

The B31.3 Code requires leak testing for all components. This test does not assess the structural integrity of the components. The Code leak test is performed at pressure levels that do not challenge the ultimate strength required by the Code. In most cases the component is subjected to the leak test after being installed in the field. All components should be reviewed to insure that their pressure/temperature rating is acceptable for the test conditions.

Some components will be qualified using a structural integrity test. The B31.3 Code accepts proof tests in accordance with the ASME B16.9, MSS SP-97, and ASME B&PV

REF-3 ASME B31.3 Process Piping Guide

Section VIII Division 1, UG-101. When components are qualified by proof test, the factor of safety between failure and the pressure rating should be as specified in the Code to which the component was tested. When a factor of safety is not specified, margins against failure that ensure safety equal to or superior to the intent of the ASME B31.3 Code must be applied.

INSTRUMENTS

Instruments are not in the scope of ASME B31.3. The Code defines the boundary to include all piping (tubing) and components used to connect instruments to other piping or equipment, but specifically excludes instruments. Instruments are usually purchased as pressure rated components. When evaluating instruments for use in pressure piping systems, the requirements of DOE Order 440.1A must be considered. This order states "When National Consensus Codes are not applicable (because of pressure range, vessel geometry, uses of special materials, etc.), implement measures to provide equivalent protection and ensure safety equal to or superior to the intent of the ASME Code."

When evaluating instruments the designer should ensure that the instruments are selected to meet the requirements of the fluid service. Specifically, the instrument's pressure/temperature rating must be equal to or exceed the design pressure and design temperature of the system. The attachment of the instrument to the piping system must meet the requirements of B31.3. When instruments are fabricated from piping components (e.g., flanges and spool pieces), the piping components must meet the requirements of B31.3.

OTHER LOADS

The design equations and rules in the B31.3 Code only address the pressure loading of components. Components must be designed for all applicable loads expected during the design life of the component. See paragraph 301 "Design Condition" of B31.3 for a listing of loads to be considered. At LANL, [ESM Structural Chapter](#) should be used to specify NPH loading.

302.3.5 Limits of Calculated Stresses due to Sustained Loads and Displacement Strains

Stress Analysis, for loading other than pressure, per ASME B31.1 is acceptable and recommended. When the B31.1 Code is used for the stress analysis, Paragraph 104.8 shall be used in its entirety. Appendix I provides guidance for stress analysis of piping systems.

302.3.5(c) Longitudinal Stresses S_L

The longitudinal stress S_L due to deadweight only can be kept within approximately 2300 psi if vertical hangers are spaced as shown in Table 2 (from ASME B31.1).

Table 2 - Spacing of Vertical Supports

Nominal Pipe Size NPS	Water Service ft.	Steam, Gas, or Air Service ft.
1	7	9
2	10	13
3	12	15
4	14	17
6	17	21
8	19	24
12	23	30
16	27	35
20	30	39
24	32	42

Notes:

1) Maximum spacing between vertical pipe supports for horizontal straight runs of standard and heavier pipe at maximum operating temperature of 750°F.

301 Does not apply where span calculations are made or where there are concentrated loads between supports, such as flanges, valves, specialties, etc.

302 The spacing is based on a fixed beam support with a bending stress not exceeding 2300 psi and insulated pipe filled with water or the equivalent weight of steel pipe for steam, gas, or air service. The pitch of the line is such that a sag of 0.1 in between supports is permissible.

303 Applied only for deadweight design. Other loading conditions must be evaluated.

302.3.6 - Limits of Calculated Stresses due to Occasional Loads

For accident (faulted) conditions and one-time non-repeated anchor motions, the allowable stress may be increased to:

$$S = \min (3S_h, 2S_y)$$

Allowables (S_h) are from B31.1 which are lower than B31.3.

304.1.2 - Straight Pipe under Internal Pressure

For the pipe size, schedule, material and design pressure/temperature combinations provided in the Piping Specifications, this section is met. **If the piping specifications in Appendix A are not applied for the pressure design, additional engineering calculations are required.**

304.2- Mitered Segments of Pipe

Additional calculations are required for mitered joints. See Appendix M for mitered joint evaluation methodology.

Section REF References

Rev. 0, 9/17/2014

REF-3 ASME B31.3 Process Piping Guide

304.3 - Branch Connections

Additional calculations are required to determine necessary reinforcement. See Appendix N for branch connection evaluation methodology.

307 - Valves

A selection guide for valves is provided in Appendix D. This guide provides information to aid in selection of the proper valve for the intended fluid service.

308.4 - Gaskets

Appendix C provides information on gasket ratings to be used in the selection of gaskets. Appendix B provides some information on compatibility of gasket materials with common fluids.

309 - Bolting

Torque values for flanged joints are provided in Appendix E.

319.4 - Flexibility Analysis

Formal flexibility analysis is not necessary if:

- 1) The design temperature is at or below 150°F and the piping is laid out with inherent flexibility

304 The design temperature is at or below 250°F and the piping is analyzed for flexibility using simplified methods of calculation.

321 - Piping Support

Design of pipe supports are addressed in Standards such as Manufacturers Standardization Society of the Valve and Fittings Industry [MSS-SP-58](#). Allowable stress levels for supports are provided in the AISC Manual of Steel Construction and the AISC Standard N690. N690 is normally reserved for safety class and safety significant systems. The ESM [Structural Chapter](#) provides more details for applications at LANL. Guidance for the design and modeling of piping supports is provided in Appendix I.

322 - Specific Piping Systems

In addition to the Code requirements, engineering practice has lead to rules of good design practice to provide for safe and cost-effective piping systems. The following are examples of such rules. These rules must be applied by competent engineers in accordance with approved procedures.

- 1) Arrangement

304.1 Piping should be grouped in banks, where feasible, and allow the most efficient support arrangement. Piping oriented in one direction should be located at the same general elevation, where feasible.

304.2 Piping arrangement should provide space for maintenance, inspection and repair of components (including disassembly).

Section REF References

Rev. 0, 9/17/2014

REF-3 ASME B31.3 Process Piping Guide

- 304.3 Piping arrangement should provide access to operating areas, corridors, observation windows, manholes and handholes.
- 304.4 Piping should conform to plant clearances above floor and grade. A minimum clearance of 7'-6" is desirable.
- 305 Vents and Drains
- 305.1 Vents and drains should be $\frac{3}{4}$ " or larger and as short as practical.
- 305.2 Drains from process lines should be piped to an appropriate collection or disposal receptacle. Drains from steam systems should be piped to boiler feedwater system when economically justified. Otherwise, they should be properly flashed and piped to waste.
- 305.3 Valves should not be installed where safety/process function of a piping system can be impeded (e.g. tank overflow lines, relief valves, vacuum breakers, etc.).
- 305.4 Caps are needed if the vent and drain lines require pressure testing.
- 305.5 Caps are needed if the fluid service presents a contamination concern.
- 305.6 Vents located outside without caps should be configured so that rainwater won't collect in the end of the piping.
- 305.7 Leakage through vent and drain valves on capped lines is a safety issue. The pressure behind the cap can be a hazard for the worker during removal. If the cap is only needed for cleanliness a small hole can be drilled in the cap or a cover without pressure retaining capability may be used.
- 306 Steam Distribution (Traps and Strainers)
- 306.1 Steam traps and strainers should be selected, located and sized by the designer. Steam trap rated capacity shall have been determined by manufacturer using [ASME Performance Test Code PTC 39.1](#).
- 306.2 A trap bypass should be installed only where a process requires uninterrupted operation and the condensate must be discharged into a closed system.
- 306.3 When a bypass is required on a bucket-type steam trap, the bypass valve must be placed above the trap to prevent loss of prime in the event of valve leakage.
- 306.4 End connections of traps and strainers should be the same as joints permitted in the design except strainer blow off connections and downstream piping may be threaded.
- 307 Buried Piping
- 307.1 See Appendix L for Guidance for the Design of Underground Process Piping Systems.
- 308 Pipe Hangers and Supports
- 308.1 Design and manufacture of standard pipe supporting elements (catalog items) should be per [MSS-SP-58](#).
- 308.2 Design of Non-standard pipe supporting elements (beams, columns, welds, etc.) should be in accordance with the requirements as prescribed by the American Institute of Steel Construction standards. Unless otherwise specified, materials should be ASTM A36.

REF-3 ASME B31.3 Process Piping Guide

308.3 Painting and galvanizing are acceptable measures for corrosion control of piping supports. When galvanized supports are specified, the galvanizing should be applied in accordance with ASTM A123 or B633-SC4, Type 1. Coating should not be applied within (or should be removed from) one inch of weld areas. Painted or galvanized areas that have been damaged during installation should be recoated.

308.4 Unless otherwise indicated on design drawings or specifications, mislocated, punched or drilled holes should be restored by welding per [AWS D1.1 Section 5.26.5](#). Mislocated holes may be left open or filled with bolting only with the written approval of the Designer.

309 Standard Pipe Sizes

309.1 The following pipe sizes (inches) are typical at LANL.

309.2 Non-typical pipe sizes NPS 3/8, 1-1/4, 3-1/2, and 5 may be used for connections to equipment, sprinkler systems and pipe jackets.

1/4	1 1/2	4	12	20
1/2	2	6	14	24
3/4	2 1/2	8	16	
1	3	10	18	

7) Valves

- a) The designer is responsible for assuring that selected valves are adequate for the service. The Designer may select alternate valves better suited for the service. Guidance for valve selection is provided in Appendix D.

310 Threaded pipe nipples should be:

310.1 seamless

310.2 the same material as non-threaded pipe, and

310.3 of schedules as indicated in the Piping Specifications or by Design

311 Galvanizing

311.1 Galvanizing is acceptable when required for external corrosion protection.

311.2 Galvanizing of pipe should be per ASTM A53.

311.3 Galvanizing of flanges, unions, and fittings should be the hot-dip process per ASTM A153. Weld end fittings NPS 4 and smaller may be black and painted after welding. Flanges and Stub Ends that are hot dipped galvanized shall be refaced to the requirements of the original Design Standard following the galvanizing process.

311.4 Galvanizing generally is a more economical weather-resistant coating than sandblasting and painting for piping NPS 4 and smaller. When a piping system requires many welded fittings the cost of grinding to remove the galvanizing for weld preparation may be more costly than painting. Use of galvanizing as a protective coating should be considered only when galvanizing is compatible with the contents of the piping.

311.5 Support components may have a zinc electroplate coating in lieu of a hot dip galvanized coating. Electroplate zinc coatings are per ASTM B633 and should specify Service Condition (SC) 4 as the required thickness.

312 Gasket and Packing

312.1 The designer is responsible for assuring that the flange and valve gaskets and valve stem packing are adequate for the intended service. Guidance for the selection of gaskets for Fluid Service application is provided in Appendix B.

Section REF References

Rev. 0, 9/17/2014

REF-3 ASME B31.3 Process Piping Guide

- 313 Erosion/Corrosion, Radiation, and Thermal Aging
- 313.1 The designer must consider the effects of erosion/corrosion, radiation, and thermal aging during the material selection process.
- 313.2 The designer must consider practices to minimize Chloride Stress Corrosion Cracking (SCC) of austenitic stainless steels. See ESM Pressure Safety Point-of-Contact.
- 313.3 When required by the design, austenitic stainless steel and other corrosion resisting alloys should be evaluated for resistance to intergranular corrosion. See ESM Pressure Safety Point-of-Contact.
- 314 Piping material limitations in radiological controlled areas:
- 314.1 Teflon thread lubricant (tape or dispersion) should be evaluated for suitability by the designer (see App C).
- 314.2 Plastic piping materials such as gaskets, packing, valve cavity liners, diaphragms, etc., should be evaluated for their suitability for use by the designer and substitutions appropriately specified in project drawings or specifications.
- 314.3 Piping joints that use degradable materials, such as gaskets, thread compounds, O-rings, etc., should be evaluated for suitability for use by the designer and substitutions appropriately specified in project drawings or specifications.
- 315 Aluminum Piping
- 315.1 When aluminum piping is joined to vessels or piping systems constructed of other metals, and the fluid handled is an electrolyte, there is a tendency for aluminum at the joint to corrode. This is a problem where the other metals are copper or carbon steel. This can be prevented by eliminating the metallic electrical path through the joint by one of the following methods:
- 315.1.1 Install a plastic flanged spool piece in the line. Check the adequacy of the plastic spool for pressure, temperature and chemical compatibility with the electrolyte. This method is preferred and has the advantage that sludge inside the line will not bridge the gap from metal to metal.
- 315.1.2 Install spool pieces of heavier wall aluminum pipe (for increased corrosion allowance). This method is especially suitable where the pipe is dismantled frequently for other reasons.
- 315.1.3 Install insulating flange kits (insulating gaskets, bolt sleeves and bolt head washers). The insulating material must be checked for chemical compatibility with the electrolyte.
- 315.2 Aluminum pipe should be insulated from carbon steel pipe supporting components. Examples of insulation are 15-pound asphalt-impregnated felt, plastic coated pipe supports, or galvanized pipe supports.
- 315.3 Aluminum flanges are not recommended. When used they should conform to the Requirements of ASME B31.3 Appendix L and be flat faced.
- 315.4 Threaded connections in aluminum piping should be avoided. Where fit-up to threaded equipment is required use minimum length schedule 80 pipe with one end threaded.
- 315.5 Thread pipe with clean, sharp dies reserved for use on aluminum only. Use cutting oil suitable for aluminum.
- 315.6 Aluminum piping should be handled carefully to avoid embedding iron and copper particles, which could cause pitting corrosion when in contact with an electrolyte.
- 316 Pump Piping

Section REF References

Rev. 0, 9/17/2014

REF-3 ASME B31.3 Process Piping Guide

- 316.1 For horizontal pumps with suction lift, when suction line is larger than inlet nozzle. The following guidance applies:
- 316.1.1 A reducer should not reduce by more than one pipe size.
- 316.1.2 For greater reduction, use a fabricated reducer with 10⁰ maximum included angle and qualify the reducer as an unlisted component.
- 316.1.3 When reducers are installed in suction lines use an eccentric reducer with the flat side on the top.
- 316.2 Elbows should not be installed directly on a pump's suction unless the elbow is equipped with straightening vanes.
- 316.3 The designer should comply with the maximum allowable pump nozzle loads where specified by the pump manufacturer.
- 317 Back Siphon/Backflow
- 317.1 Physical connections made between domestic water system and any industrial piping system, vessel, or other equipment should be designed and installed to prevent backflow and back siphonage. See ESM Chapter 6 Section D20, Cross Connection Control subsection.

III - MATERIALS

See Appendix C for general guidance for materials selection.

See Appendix O for additional material requirements for Safety Class Piping Systems.

Fluid Service Sheets are provided in Appendix B to provide guidance on the selection of material for compatibility with the specified fluid service.

IV -STANDARDS FOR PIPING COMPONENTS**326 - Dimensions and Ratings of Components**

ASME B31.3 Table 326.1 (also A326.1 and K326.1) identifies component standards that are "listed." Unlisted components (components made to standards or specifications not identified in Table 326.1) must be qualified per ASME B31.3 paragraphs 302.2.3 and 304. Proof of qualification is the responsibility of the Owner (LANL Design Authority) or Designer (See Paragraph 302.2 of this Guide).

A component to be used in a Code application must be listed in the Code and marked to Code requirements. Marking requirements for common components are provided in Appendix G.

V - FABRICATION, ASSEMBLY AND ERECTION**328 - Welding**

Welding requirements of B31.3 are met by following the requirements identified in the LANL Welding Manuals (Future).

328.5.2 - Fillet Weld

The minimum fillet weld sizes required by B31.1 and B31.3 for slip-on flange and socket weld connections are listed in Appendix J.

332 - Bending

- 1) The following guidance is provided for bending:
 - a) Hot bending of piping should be performed in accordance with written procedures. Hot bending of austenitic stainless steels should be followed by a full solution anneal in accordance with written procedures.
 - b) No bending should be performed at metal temperatures less than 40°F.
 - c) Cold bending may be performed using hydraulic or mechanical bending machines. Bending machines should be qualified by test for pipe minimum wall and ovality.
 - d) Mandrel and die used in bending stainless steel piping should be free of zinc.
 - e) Pipe longitudinal welds should not be located within 30 degrees of the plane of bend measured axially from the pipe centerline.
 - f) Necking as determined by reduction of the outside circumference should not exceed 4%.
 - g) Creased or corrugated bends are not permitted.
 - h) After bending, the finished surface should be free of cracks and substantially free from buckling, by visual inspection. Depth of wrinkles on the inside of the bend as determined from crest to trough should not exceed 1.5% of the nominal pipe size.
 - i) Flattening or ovality of a bend, the difference between maximum and minimum diameters at any cross section, should not exceed 8% of nominal outside diameter for internal pressure and 3% for external pressure.
 - j) Wall thinning in piping shall not exceed:
 - i) 10% - Bend radius of 5 pipe diameters and larger
 - ii) 21% - Bend radius of 3 pipe diameters.
 - k) Wall thinning in tubing shall not exceed:
 - i) 12% - Bend radius of 5 pipe diameters
 - ii) 22% - Bend radius of 3 pipe diameters
 - iii) 37% - Bend radius of 1.5 pipe diameters

318 Tube bending differs from pipe bending in that it is usually performed in the field with a manually operated bender. The following guidance is provided to ensure good results on each bend.

- a) Measure and mark exactly, then insert tube in bender.
- b) Always attempt to bend in the same direction. If backbending, be sure to compensate for tubing stretch or pickup.
- c) Clamp tubing securely in bender.
- d) Check to make certain that the length mark is tangent to the desired angle on the radius block or in line with the desired degree on the link member.
- e) Bend accurately to the desired angle plus springback allowance.
- f) Remove tube and check bend angle and measurement length.

REF-3 ASME B31.3 Process Piping Guide

335 - Assembly and Erection

- 1) For tolerances on fabrication, refer to the Pipe Fabrication Institute Standard ES-3, "Fabrication Tolerances".

319 Typical tolerances for erection (field installation) are the larger of 6" or D/2 for safety related piping and 12" or D for non-safety related piping, while maintaining code, design and vendor alignment and slope requirements. Tolerance must not affect the sequential location of components, and fittings.

320 The following general requirements apply to buried pipe:

- a) For installation of buried process piping refer to Appendix L.
- b) Permits from the New Mexico Environment Department and environmental impact reports for the DOE may be required.
- c) Bedding material should be granular, well graded and capable of being compacted flat
- d) Backfill or fill material should contain no rocks and stones larger than 3 inch in the greatest dimension and should be free of frozen lumps, vegetable matter, trash, chunks or highly plastic clay or other unsatisfactory matter.
- e) As an option, Controlled Low Strength Material (CLSM or "flowable fill") may be substituted for bedding material, embedment material or backfill material.
- f) Prior to excavation, the existing underground structures and/or utilities should be located.
- g) Where the trench bottom is unstable or contains unsuitable material, this material should be excavated to a minimum depth of 6". The excavated material should then be replaced with suitable material, or CLSM.
- h) Compaction testing of bedding (excluding CLSM materials) should be done at frequencies specified by design in any location specified by the cognizant inspection authority. Bedding sections failing to meet these specifications shall be removed and replaced, or reworked.
- i) The minimum depth of cover shall be 30" (top of pipe to finished grade).
- j) The minimum slope or grade indicated on design documents shall be maintained regardless of other installation tolerance.
- k) The use of vertical installation tolerance shall not increase unvented high points unless these are explicitly approved.
- l) Upon completion of installation, record the as-installed piping geometry to within the tolerance as shown below:
 - i) Vertical plane = ± 1 "
 - ii) Horizontal plane = ± 3 "

335.1.1(a) - Alignment (Piping Distortions)

Allowable misalignment and fit-up tolerances are provided in Appendix F.

REF-3 ASME B31.3 Process Piping Guide

335.1.1(c) - Alignment (Flanged Joints)

The allowable flange gaps per B31.3 are provided in Appendix E. Allowable flange rotations above those provided in the Code are provided in Appendix F.

335.2 - Flanged Joints

Refer to Appendix E for guidance on the proper installation of flanged connections.

335.3 - Threaded Joints

1) Threaded components and threaded ends are examined before assembly for cleanliness and continuity of threads and are in conformance with applicable standards.

321 Compound or lubricant used on threads is suitable for the service conditions and shall not react unfavorably with either the service fluid or the piping material.

322 Threaded joints to be seal welded are made up without thread compound or lubricants.

323 When design requires threaded piping to be seal welded, seal welds shall cover all exposed threads.

324 Installation of threaded joints involves the cutting of threads and assembly of the joint. Cutting threads with a hand threader involves the following steps. Threads may also be cut with a power threader.

- a) Select the proper size of die.
- b) Clean surface of pipe. Be sure the end is square and free of burrs. Tapering the end of pipe is helpful starting the dies.
- c) Mount the threader on the pipe making sure that the taper is headed in the forward direction.
- d) Use thread cutting oil.
- e) Pressure should be applied to start dies on pipe.
- f) The thread length is correct when the outer surface of die is even with the end of the pipe.
- g) Remove die and clean threads with brush or rag.
- h) Apply joint compound or tape that has been approved by the Facility for the application.
- i) Hand tighten fitting, then tighten to required degree of tightness with correct wrench.

335.6. -(a) Expanded Joints and Special Joints

Special precautions should be taken for any piping system containing an expansion joint assembly.

1) The manufacturer's and/or designer's special installation instructions shall be followed.

325 Expansion joint assemblies should be carefully unpacked and erected to avoid mechanical damage to the assemblies while handling or rigging. Erection straps or

REF-3 ASME B31.3 Process Piping Guide

chains shall not be loaded against or connected to bellows elements, covers or any assembly hardware during erection.

326 Prior to connecting or installing an expansion joint assembly, the erector should inspect the assembly to insure that all factory-installed shipping bars, brackets or other locking devices are in place. No modification to or removal of these devices shall be permitted until after the piping system closures are completed.

327 The expansion joint assembly may be equipped with permanent tie rods or limit rods, which are necessary for the functional operation of the joint assembly. Where provided, these rods shall not be removed, nor their factory set lengths and clearances modified, without approval by the designer.

328 An expansion joint assembly shall not be exposed to hydrostatic test or pressure flushing operations until all permanent anchors, guides and restraints are installed on the piping system. Hydrostatic test or flushing pressure shall not be greater than the manufacturer's recommended test pressure. All temporary shipping bars or brackets should be removed prior to system pressurization.

335.6. - (b) Special Joint - Compression Fittings

Specialty fittings are considered as unlisted component but are acceptable for use where identified in the attached Piping Specifications. The following guidance is essential for the proper installation and maintenance of compression fittings. The following instructions are applicable to Swagelok and Parker fittings.

1) Ends must be cut square. The preferred method of cutting tubing is by hacksaw with suitable guide for squareness. Tube cutters should not be used for stainless steel due to work hardening.

329 Burrs must be removed inside and outside for proper entry into fitting and to prevent system contamination and or restricted flow.

330 Tube ends must be clean. Remove all filings, chips, and grit before attachment of fittings.

331 Tube line fabrication (bend angles and measured lengths) must be accurate so that the tube end easily enters the fitting in proper alignment. Do not force an improperly fitted tube line into the fittings.

332 The tube end must be bottomed against the shoulder in the fitting body. This is necessary to prevent movement of the tube while the nut forces the ferrule to grip the tube, and to seal through any imperfections that may exist on the outside tube surface.

333 Never permit the fitting body to rotate during tube end make-up. **Two wrenches must be used.** Assemble port connectors to components first and hold with wrench while making up the tube joint. All types of union bodies must be held while each of the tube ends is made up.

334 Never attempt to make up by torque or feel. Always turn the nut the prescribed amount (listed below) regardless of the torque required.

Sizes 1/16" - 3/16"	¾ of a turn from finger tight
Sizes ¼ "- 1"	1 ¼ turns from finger tight

Note: Fitting end plugs require only ¼ " turn from finger tight make up in all sizes.

REF-3 ASME B31.3 Process Piping Guide

335.6. -(c) Remaking an Existing Joint

Remaking an existing joint is as important as the initial installation. The following instructions are provided for the remake of these joints.

- 1) A disassembled joint can be remade simply by retightening the nut to the position of the original make-up. For maximum number of remakes, mark the fitting and nut before disassembly.

335 Before retightening, make sure the components are clean and that the assembly has been inserted into the fitting until the ferrule(s) seats in the fitting.

336 Retighten the nut by hand. Rotate the nut with a wrench to the original position as indicated by the previous marks lining up. A noticeable increase in mechanical resistance will be felt indicating the ferrule is being re-sprung into sealing position. Then snug the nut 1/12 turn (1/2 hex flat) past the original position.

337 Check ferrule orientation when applicable.

338 Use gap gage when applicable.

VI - INSPECTION, EXAMINATION AND TESTING

340.4- Qualification of the Owner’s Inspectors

Qualification of individuals performing the Owner’s Inspector Function shall meet the requirements of this paragraph. Owner’s Inspectors are designated by the Site Chief Engineer. Refer to the IFMP Training and Qualification Program ACP-T&Q-01 (future).

341.4 - Extent of Required Examination

"Examination" is not limited to welds. Records, materials, fabrication, erection pressure testing, as-built, must also be examined as specified by Code. Refer to Table 3 for a list of examination attributes and the extent of required examination.

Table 3 - EXAMINATION OF MATERIALS, FABRICATION AND INSTALLATION

Extent of Required Examination							
	Material	Fabrication	Fabrication of Longitudinal Welds	Mechanical Joints	Erection	Complete system Meets Design (2)	Other Examinations
Category D	Random	Random	Random	Random	Random	Random	Random (3)
Normal	Random	5%(5)	100%	Random(1)	Random	Random	5% Vol. (4)
Category M	Random	100%	100%	100%	Random	Random	20% Vol.
High Pressure	100%	100%	100%	100%	Random	Random	100% Rad.
Severe Cyclic	Random	100%	100%	100%	100%	Random	100% Vol.
Notes: (1) When pneumatic testing is to be used, 100% of mechanical joints shall be examined. (2) Includes any additional examination or testing required by engineering. (3) Category D Systems require welds to be random visually examined.				(4) When brazed joints are used, 5% in-process examination is performed. (5) Socket welds require 5% visual examination of final weld. Note: Vol = Volumetric weld examination such as a radiograph or ultrasonic. Rad = Radiography			

Guidance of specific examinations other than welds is provided below. This is not intended to be an all-inclusive list of items to be examined.

REF-3 ASME B31.3 Process Piping Guide

MATERIAL

- 1) At point of installation, materials and components are sufficiently identified by markings, tags, or documentation to assure they are in accordance with the specified requirements and traceable to the required documentation.

FABRICATION

- 1) After bending, the finished surface should be free of cracks and substantially free from buckling, by visual inspection. Depth of wrinkles on the inside of the bend as determined from crest to trough should not exceed 1.5% of the nominal pipe size.
- 339 Thinning of wall thickness after bending and forming of pipe does not exceed the following: 10% for bend radii of greater than or equal to 5 pipe diameters, or 21% for bend radii of less than or equal to 3 pipe diameters.
- 340 Thinning of wall thickness after bending and forming of tube does not exceed the following: 12% for bend radii of greater than or equal to 5 pipe diameters, 22% for bend radii of less than or equal to 3 pipe diameters, or 37% for bend radii of less than or equal to 3 pipe diameters.
- 341 Necking down after bending and forming as determined by reduction of the outside circumference does not exceed 4%.
- 342 Flattening or ovality of a bend, the difference between maximum and minimum diameters at any cross section, does not exceed 8% of nominal outside diameter for internal pressure and 3% for external pressure.
- 343 Cold bending is done at a temperature below the transformation range.
- 344 No pipe bending is performed at metal temperatures less than 40°F.
- 345 Hot bending is performed to a design approved procedure.
- 346 Longitudinal weldments are not located within 30 degrees of the plane of bend.
- 347 Welding examinations are per the LANL Welding Manuals (future).

FABRICATION OF LONGITUDINAL WELDS

- 1) Perform radiography for longitudinal groove welds required to have a weld joint factor E_i equal to or greater than 0.90.

MECHANICAL JOINTS

- 1) Threads in the bolts and nuts to be free from nicks, burrs, grit, chips, and dirt and well lubricated prior to makeup.
- 348 Bolts extend completely through their nuts.
- 349 Manufacturer's and designer's installation instructions for expansion joints has been followed, and all factory installed shipping bars, brackets, or other locking devices are in place and remain in place until after piping system closures are complete.
- 350 Any damage to the gasket seating surface which would prevent gasket seating has been repaired, or the flange replaced. Refer to Appendix E.
- 351 The nuts have been tightened in a staggered crisscross pattern and in increments of not more than 1/3 the total required torque.
- 352 No more than one gasket is used between contact faces in assembling a flanged joint.

Section REF References

Rev. 0, 9/17/2014

REF-3 ASME B31.3 Process Piping Guide

- 353 Galvanized flanges must be refaced with the appropriate surface finish after galvanizing in complete.
- 354 Prior to bolt up, flange faces are aligned within 1/16" in./ft. (0.5%) measured across any diameter and flange bolt holes are aligned within 1/8" maximum offset. Refer to Appendix F for guidance on misalignment fit-up tolerance.
- 355 Sealing surfaces of the flare of flared tubing joints are examined for imperfections before assembly.
- 356 Where the manufacturer's instructions call for a specified number of turns of the nut, these shall be counted from the point at which the nut becomes finger tight.
- 357 Threaded components are examined before assembly for cleanliness and continuity of threads and for conformance of threads with applicable standards.
- 358 Compound or lubricant used on threads (for components and bolts) is suitable for the service conditions and shall not react unfavorably with either the service fluid or the piping material.
- 359 Threaded joints to be seal welded are made up without thread compound or lubricant.
- 360 When design requires threaded piping to be seal welded, seal welds shall cover all exposed threads.

ERECTION

- 1) Piping is not distorted to bring it into alignment for joint assembly.
- 361 Wedges are not being used to laterally contain or position pipe for closure fit-ups.
- 362 The amount and direction of cold spring, (defined as the intentional deformation of piping during assembly to produce a desired initial displacement and stress) is in accordance with the design values.
- 363 Support locations, type, and restraint direction are as specified in the design drawing.
- 364 Pipe slope has been maintained in the direction specified by the slope arrow and/or work point elevation indicated on the design drawing.
- 365 Changes in piping elevation have not impacted slope requirements, high point vents, or low point drains.
- 366 Upon completion of installation the as-installed piping geometry has been recorded on the design documents. Typical tolerances for erection (field installation) are the larger of 6" or D/2 for safety-related piping or 12" or D/2 for non-safety related piping, while maintaining code, design and vendor alignment and slope requirements. Tolerance must not affect the sequential location of components and fittings, or the centerline lengths.
- 367 Valves and other components are oriented as shown in design documents or manufacturer's requirements.
- 368 Insulation is installed as specified.
- 369 There are no visible defects, missing or damaged parts in piping, components, or piping supports.

COMPLETE SYSTEM MEETS DESIGN

- 1) Examination of erected piping for evidence of defects that would require repair or replacement, and for other evident deviation from the intent of the design.
- 370 Any additional requirements supplementing the Code as specified by the design.

Section REF References

Rev. 0, 9/17/2014

REF-3 ASME B31.3 Process Piping Guide

371 Cleanliness of piping is in accordance with the requirements of the applicable standard or as specified by design.

OTHER

- 1) Welding examination requirements are per the LANL Welding Manuals (future).

341.4.1(b)(1)- Other Examinations

In-process examination may be substituted for volumetric examination on a weld-for-weld basis, if volumetric examination of a particular weld is prohibitive. This substitution cannot be granted across the board for a whole job.

Requirements for examinations of repairs and alterations of in-service piping are provided in Appendix P.

342- Examination Personnel

Examiners shall have training and experience commensurate with the needs of the specified examinations. The employer shall certify records of examiners employed, showing dates and results of personnel qualifications, and shall maintain them and make them available to the Inspector. Examinations other than welds shall be conducted per the PS Division requirements.

345 - Testing

Table 4 is a summary of the leak test requirements of B31.3. Refer to Appendix P for testing requirements associated with Repairs, Alterations, and Modifications.

Guidance for performing Leak/Pressure testing is provided in Appendix H.

TABLE 4 - LEAK TESTING MATRIX

For Initial Installations & Fabricated Subassemblies

Fluid Service/ Piping Type	Type of Test					
	Hydrostatic	Pneumatic	Combined Hydro/Pneu.	Alternative	Sensitive	Initial Service
Category D Metallic	Primary leak test method	May be substituted in lieu of the hydrostatic method when approved by the Owner.	May be substituted in lieu of the hydrostatic method when approved by the Owner.	May be substituted for the hydrostatic or pneumatic leak tests (1)	Part of the Alternative Leak Test	May be used at the Owner's option in lieu of the hydrostatic leak test
Category D Non-Metallic	Primary leak test method	May be substituted in lieu of the hydrostatic method when approved by the Owner.	May be substituted in lieu of the hydrostatic method when approved by the Owner.	Not Applicable	Not Applicable	May be used at the Owner's option in lieu of the hydrostatic leak test
Normal Fluid Service Metallic	Primary leak test method	May be substituted in lieu of the hydrostatic method when approved by the Owner.	May be substituted in lieu of the hydrostatic method when approved by the Owner.	May be substituted for the hydrostatic or pneumatic leak tests (1)	Part of the Alternative Leak Test	Not Applicable
Normal Fluid Service Non-Metallic	Primary leak test method	May be substituted in lieu of the hydrostatic method when approved by the Owner.	May be substituted in lieu of the hydrostatic method when approved by the Owner.	Not Applicable	Not Applicable	Not Applicable
Category M Metallic	Primary leak test method. Requires additional Sensitive Leak Test.	May be substituted in lieu of the hydrostatic method when approved by the Owner. Requires additional Sensitive Leak Test.	May be substituted in lieu of the hydrostatic method when approved by the Owner. Requires additional Sensitive Leak Test.	May be substituted for the hydrostatic or pneumatic leak tests (1)	Required to be used in conjunction with hydro, pneu, combined test methods, or as a part of the Alternative Leak Test	Not Applicable
Category M Non-Metallic	Primary leak test method	May be substituted in lieu of the hydrostatic method when approved by the Owner.	May be substituted in lieu of the hydrostatic method when approved by the Owner.	Not Applicable	Not Applicable	Not Applicable
High Pressure Metallic	Primary leak test method (2)	May be substituted in lieu of the hydrostatic method (2)	May be substituted in lieu of the hydrostatic method (2)	Not Applicable	Not Applicable	Not Applicable

(1) May be substituted for the hydrostatic or pneumatic leak tests provided: a) The Owner has determined a hydrostatic test would damage linings or internal insulation, or contaminate a process which would be hazardous, corrosive, or inoperative in the presence of moisture, or would present the danger of brittle fracture due to low metal temperature during the test. b) The Owner has determined a pneumatic test would present undue hazard of possible releases of energy stored in the system, or would present the danger of brittle fracture due to low metal temperature during the test. In either case approval of the ESM Pressure Safety Point-of-Contact must be obtained.

(2) Additionally the piping in the installed configuration must be tested to 110% of the design pressure.

APPENDIX A – PIPING SPECIFICATIONS

The attached piping specifications provide the required data to meet the pressure design requirements of the ASME B31.3 piping code. Additional requirements and competent engineering are required to provide a safe and complete piping system design. Additional requirements include material selection, functional design, system layout, component selection, support design, thermal expansion, stress analysis, examination and testing. These specifications must be used in conjunction with ASME B31.3 and this Guide to ensure a sufficient piping system design.

WARNING

Successful application of each piping specification requires the reading and comprehension of all applicable General Notes.

When these guides are not applied in the pressure design of a piping system additional calculations are required.

The Piping Specifications are organized as follows:

100 Series	Carbon Steels
200 Series	Stainless Steels
300 Series	High Alloy Steels
400 Series	Nonferrous
500 Series	Nonmetals
900 Series	Non-ASME B31.3 Codes

Required Input

The following input is required to select a piping specification. Figure A-1 illustrates the procedure for the selection of the correct piping specification.

DESIGN CODE

Most of the Piping Specifications address the ASME B31.3 Piping Code. The B31.3 Code Scope applies to the majority of process applications at LANL. Additional ASME B31.1 and AWWA piping specifications are provided to address applications specific to the scope of these Codes. The user is responsible for compliance with all aspects of the design Code being applied. This Guide addresses only B31.3, however this guidance is typical of the requirements in other Codes.

FLUID SERVICE CATEGORY

The fluid service (Category D, Normal, Category M, or High Pressure) is a term used in ASME B31.3 that considers the combination of fluid properties, operating conditions, and other factors that establish the basis for design of the piping system. The piping specifications were developed to address the requirements of ASME B31.3 Normal Fluid Service Category and/or Category D requirements. Normal Fluid Service piping specifications may be used for Category D fluid services without restrictions. The fluid service is indicated on each piping specification in the design parameters section. For Category M fluid services, and systems subjected to severe cyclic conditions, additional restrictions apply. These additional restrictions shall be addressed by Engineering. See Appendix M of ASME B31.3 for guidance in classifying the fluid service category.

MATERIAL AND CORROSION ALLOWANCE

Selection of suitable piping materials to resist deterioration in service is required to provide a safe piping design. A corrosion/erosion allowance will need to be determined to provide the required wall thickness. The corrosion allowance shall be specified by the letter suffix (A, B, C, or D) in the piping specification identification (e.g., PS-101A). The fluid service will also affect the selection of materials such as gaskets, valve seats and packing. Issues related to material selection should be addressed by Engineering. Guidance for material compatibility is provided in Appendices B and C.

DESIGN PRESSURE

The design pressure of a piping system is the pressure at the most severe condition of coincident internal or external pressure and temperature expected during service. Examples of the design pressure in a piping system include the deadhead pressure of a pump or the relief valve set pressure.

The most severe condition is that which results in the greatest required component thickness and the highest component ratings.

DESIGN TEMPERATURE

The design temperature of a piping system is the temperature at the most severe condition of coincident pressure expected during service.

With the above inputs, the different component options provided in the piping specifications can be used to meet the pressure design of a piping system. Selection of the different options provided in the piping specification (i.e. socket-weld vs. butt-weld fittings, slip-on vs. weld neck flanges etc.) will affect the stress levels in the piping system. Components in an existing piping system shall be replaced in kind. If components are changed in an existing piping system these changes shall be addressed by Engineering. For new piping system design specific requirements for options shall be specified on the design drawings.

COMPONENTS

Piping components not provided in the piping specification can be selected from the standards listed in ASME B31.3.

Components of higher pressure rating may be used in the piping specification without additional analysis. All changes shall be documented on design drawings.

UNLISTED COMPONENT QUALIFICATION

Components used in piping systems not conforming to listed standards in B31.3 are considered unlisted by the Code and require additional qualification.

Figure A-1 Flow Chart for Piping Specification Applications

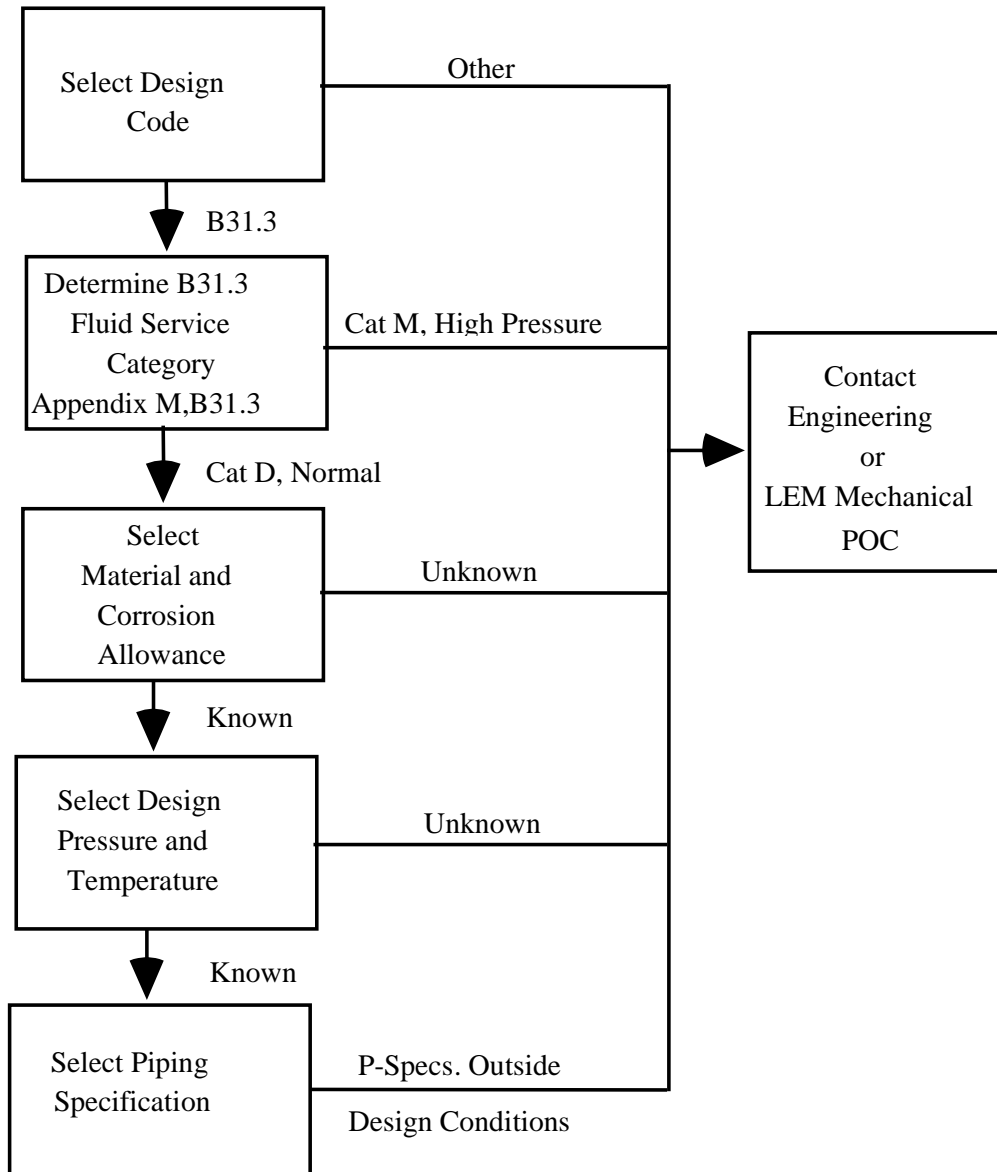

Piping Specification Revision Control Page				
Piping Specification	Title	Revision	Description of Revision	Pages
PS-101	Class 150 Carbon Steel	0	Original Issue	1
PS-102	Carbon Steel (B16.3)	0	Original Issue	1
PS-103	Class 300 Carbon Steel	0	Original Issue	1
PS-104	Class 400 Carbon Steel	0	Original Issue	1
PS-105	Class 600 Carbon Steel	0	Original Issue	1
PS-106	Rating 1000 psi, Carbon Steel	0	Original Issue	1
PS-107	Class 1500, Carbon Steel	0	Original Issue	1
PS-108	Class 2500, Carbon Steel	0	Original Issue	1
PS-109	Victaulic Zero-flex, Carbon Steel	0	Original Issue	1
PS-200	Class 150 304L Stainless Steel	0	Original Issue	1
PS-201	Class 150 316L Stainless Steel	0	Original Issue	1
PS-202	Class 300 304L Stainless Steel	0	Original Issue	1
PS-203	Class 300 316L Stainless Steel	0	Original Issue	1
PS-204	304L Stainless Steel Tubing	0	Original Issue	1
PS-205	304L Stainless Steel Tubing	0	Original Issue	1
PS-206	316L Stainless Steel Tubing	0	Original Issue	1
PS-207	316L Stainless Steel Tubing	0	Original Issue	1
PS-208	Class 400 304L Stainless Steel	0	Original Issue	1
PS-209	Class 600 304L Stainless Steel	0	Original Issue	1
PS-210	Rating 600 psi, 304L Seamless	0	Original Issue	1
PS-211	Rating 600 psi, 316L Seamless	0	Original Issue	1
PS-212	Rating 1225 psi, 304L Seamless	0	Original Issue	1
PS-213	Class 1500, 304L Seamless	0	Original Issue	1
PS-214	Class 2500, 304L Seamless	0	Original Issue	1
PS-215	Victaulic Zero-flex, 316L 10S	0	Original Issue	1
PS-300	Class 150 Hastelloy C276	0	Original Issue	1
PS-301	Class 300 Hastelloy C276	0	Original Issue	1
PS-302	Class 150 Alloy 20	0	Original Issue	1
PS-303	Class 300 Alloy 20	0	Original Issue	1
PS-304	Class 150 Inconel 600	0	Original Issue	1
PS-305	Class 150 Inconel 690	0	Original Issue	1
PS-306	Class 150 Monel	0	Original Issue	1
PS-400	Copper Tubing Category D	0	Original Issue	1
PS-401	Copper Tubing - Class 150	0	Original Issue	1
PS-402	Copper Tubing - Type L	0	Original Issue	1
PS-403	Copper Tubing - B280	0	Original Issue	1
PS-404	Class 150 Aluminum Pipe	0	Original Issue	1
PS-405	Class 150 Aluminum Tube	0	Original Issue	1
PS-500	150 psi PVC	0	Original Issue	1
PS-501	150 psi CPVC	0	Original Issue	1
PS-502	200 psi Polyethylene (PE)	0	Original Issue	1
PS-900	B31.1 Class 150 Carbon Steel	0	Original Issue	1
PS-901	B31.1 Class 300 Carbon Steel	0	Original Issue	1
PS-902	B31.1 Class 600 Carbon Steel	0	Original Issue	1
PS-903	AWWA PVC	0	Original Issue	1
PS-904	AWWA Ductile Iron	0	Original Issue	1

General Notes

Successful application of each piping specification requires the reading and comprehension of all applicable General Notes.

- 1 This specification provides the necessary information to meet the pressure design requirements of the ASME B31.3 piping code. Additional requirements include, but are not limited to, support design, thermal expansion, material selection, examination, and testing. These additional requirements are addressed in ASME B31.3 and this Guide.
- 2 This specification was developed to address the requirements of ASME B31.3 Normal Fluid Service. This specification may be used for Category D fluid services without restrictions. For Category M fluid services, and systems subjected to severe cyclic conditions, additional restrictions apply. These additional restrictions shall be addressed by Engineering.
- 3 Selections of the different options provided in this specification (e.g., socket-weld vs. butt-weld fittings, slip-on vs. weld-neck flanges, etc.) will affect the stress levels in the system. Components in an existing system shall be replaced in kind. If components are changed in an existing system, these changes shall be addressed by Engineering. For new system design, specific requirements for options shall be specified on the design drawings.
- 4 To address the fluid service requirements of a piping system, a corrosion allowance will need to be determined to select the required wall thickness. The fluid service requirements will also affect the selection of materials such as gaskets, valve seats and packing, etc. The corrosion allowance shall be specified by the letter suffix in the piping specification identification (e.g., PS-101A).
- 5 The minimum test pressures to meet the hydrostatic test limits of the applicable code (i.e. ASME B31.1 or B31.3) are provided in the Design Parameters table in this specification for the listed design pressures and temperatures. Actual system design pressures should be used to establish hydrostatic test pressures for testing. These test pressures are the minimum pressure requirements to be achieved throughout the piping system, adjustments may be required to account for elevation changes in the piping system. The maximum test pressure provided in the design parameters is the lowest pressure at which the pipe size/schedule combination reaches its yield stress. These pressures shall not be exceeded at any location in the piping system. Valves, instruments, fittings and other components may have additional pressure limitations and may require isolation from the test pressure.
- 6 Additional analysis is required to increase the external pressure rating.
- 7 Components not provided in the specification can be selected from the standards listed in Table 326.1 of ASME B31.3. Components used in piping systems that are not listed in this table are considered unlisted by the Code and require additional qualification. See ASME B31.3 paragraph 304.7.2. All components must meet the temperature/pressure requirements.
- 8 The minimum design temperature may be limited by the need for impact testing of material and the qualification of the welding procedure. The temperature limits of the fasteners may also control the minimum design temperature.
- 9 Components with higher pressure ratings (e.g., thicker pipe or higher rated fittings and flanges) may be used without additional analysis. If such components are mixed within system, additional weld prep to match diameters may be required. All changes shall be documented on design drawings.
- 10 Appendix E provides guidelines for the installation of fasteners and the selection of alternate fasteners. Studs are the recommended fasteners for connecting flanges in piping systems.
- 11 Branch connections shall be made with Tees for full size and one size smaller branches, and for all run sizes NPS 2 and smaller. Welded branch connections are otherwise permitted, and shall be reinforced as required (see Appendix N).
- 12 3D bends are permitted for pipe sizes up to NPS 6.
- 13 Bends are not permitted for this piping specification.
- 14 5D bends are permitted up to NPS 6.

Section REF References

Rev. 0, 9/17/2014

REF-3 ASME B31.3 Process Piping Guide

- 15 5D bends are permissible up to NPS 2.5.
- 16 Piping with high corrosion rates or subject to IGSCC may require the use of corrosion-evaluated materials. When corrosion evaluation is required, this specification shall be identified as PS-number (A,B,C,D)-CE (e.g. PS-200A-CE).
- 17 Tubing purchased to ASTM A269 shall require that CMTRs must specify mechanical testing to comply with ASME B31.3.
- 18 Welded fittings are to be of L-Grade material only.
- 19 Flange material and pressure/temperature rating shall be selected based on ASME B16.5 and the actual system design pressure and temperature.
- 20 This specification was developed to address the requirements of ASME B31.3 Category D Fluid Service. This specification is not to be used for other fluid service categories
- 21 Type K tubing may be substituted for Type L tubing.
- 22 When hardened temper copper tubing (e.g., H temper) is used, the tubing shall be annealed before bending or flaring.
- 23 Soldering or brazing is allowed with this tubing specification. Soldered joints shall be made with 95-5 Tin-Antimony solder.
- 24 Qualification of the Copper Tubing in this P-Spec is based on properties of annealed material.
- 25 This specification was developed to address the requirements of ASME B31.3 Normal Fluid Service, and may not be used in Category M fluid service
- 26 Brazing of the joints is required with this tubing specification. The use of soft solder is not permitted.
- 27 ASME B16.15, B16.18, and B16.22 fittings should be ordered 1/8 inch less than the tube O.D. when used with ASTM B280 tubing.
- 28 Branch connections shall be made with fittings in all sizes.
- 29 Piping in all Fluid Services except Category D shall be safeguarded per ASME B31.3.
- 30 Ultraviolet inhibitor shall be specified if piping is to be used above ground.
- 31 SDR Rated pipe per ASTM F442 is acceptable and shall be SDR 26 or lower. This pipe shall not be threaded.
- 32 Pressure ratings for 100° F may be determined by multiplying the above design pressures by 0.625. For example, DR 9 pipe would be rated at 125 psig at 100° F (200 psig times 0.625 = 125 psig).
- 33 This pipe and tube is ordered based on pressure rated diameter to thickness ratios (DR). To address the different Dimension Ratios (DRs) identified in this piping specification, the appropriate letter suffix shall be specified to identify which DR is required (e.g. PS-502F). The DRs to which the letter suffixes correspond is identified in the Design Parameters section of the specification and the Required DR Schedules are also listed in the specification.
- 34 This piping specification provides the required information to meet the pressure design requirements of ASME B31.1 piping code. Additional requirements include, but are not limited to, support design, thermal expansion, material selection, examination, and testing. These additional requirements are addressed in ASME B31.1 and this Guide.
- 35 This piping specification was developed to address the requirements of ASME B31.1 Non Boiler External Piping. This specification may not be used for Boiler External Piping without additional restrictions.
- 36 Piping components not provided in this piping specification can be selected from the standards listed in Table 126.1 of ASME B31.1. Components used in piping systems that are not listed in this table are considered unlisted by the Code and require additional qualification. See ASME B31.1 paragraph 104.7.2. All components must meet the temperature/pressure requirements of the system.

Section REF References

Rev. 0, 9/17/2014

REF-3 ASME B31.3 Process Piping Guide

- 37 The minimum test pressures to meet the hydrostatic test limits of ASME B31.1 are provided in the Design Parameters table in each specification for the listed design pressures and temperatures. Actual system design pressures should be used to establish hydrostatic test pressures for testing. These test pressures are the minimum pressure requirements to be achieved throughout the piping system, adjustments may be required to account for elevation changes in the piping system. The maximum test pressure provided in the schedule tables of the specification represent the pressure where the piping reaches its yield stress. These pressures shall not be exceeded at any location in the piping system. Valves, instruments, fittings and other components may have additional pressure limitations and may require isolation from the test pressure.
- 38 Where steel pipe is threaded and used for steam service above 250 psi or for water service above 100 psi with water temperatures above 220° F, the pipe shall be seamless and have a thickness at least equal to schedule 80 of ASME B36.10.
- 39 Consult engineering for selection of fasteners in fluid services above 600° F.
- 40 This piping specification provides the required information to meet the pressure design requirements of the AWWA piping. Additional requirements include, but are not limited to, support design, thermal expansion, material selection, examination, and testing. These additional requirements are addressed in [AWWA Manual M23 "PVC Pipe – Design and Installation."](#)
- 41 This piping specification was NOT developed to address the requirements of ASME B31.3. This specification may be used for ASME B31.3 service only when the additional requirements of ASME B31.3 are addressed and implemented.
- 42 The minimum test pressures to meet the hydrostatic test limits of AWWA M23 are provided in the Design Parameters table in each specification for the listed design pressures and temperatures. Actual system design pressures should be used to establish hydrostatic test pressures for testing. These test pressures are the minimum pressure requirements to be achieved at the source of pressurization. When accounting for elevation, the high point of the system must be subjected to at least 188 psi. The maximum test pressure provided in the schedule table of the specification represents a 10% increase above the minimum. These pressures shall not be exceeded at any location in the piping system. Valves, instruments, fittings and other components may have additional pressure limitations and may require isolation for the test pressure.
- 43 Installation, examination and testing shall be per AWWA M23.
- 44 Piping components not provided in this piping specification can be selected from the appropriate standards that meet the design requirements of AWWA. Components used in piping systems that are not listed in this table are considered unlisted by the Code and require additional qualification.
- 45 Cast Iron mechanical joint fittings can damage PVC pipe if over tightened. Consult pipe manufacturer for guidance concerning installation of these fitting.
- 46 This piping specification provides the required information to meet the pressure design requirements of the AWWA piping. Additional requirements include, but are not limited to, support design, thermal expansion, material selection, examination, and testing. These additional requirements are addressed in AWWA C600 "Installation of Ductile Iron Water Mains and Their Appurtenances". Additionally, the required thickness of ductile iron pipe is dependent on the laying conditions for buried pipe. This should be verified by Design prior to specification of the pipe, and is addressed in AWWA C150 "Thickness Design of Ductile Iron Pipe".
- 47 The minimum test pressures to meet the hydrostatic test limits of AWWA C600 are provided in the Design Parameters table for the listed design pressures and temperatures. Actual system design pressures should be used to establish hydrostatic test pressures. These test pressures are the minimum pressure requirements to be achieved at the source of pressurization. When accounting for elevation, the high point of the system must be subjected to at least 313 psi. The maximum test pressure provided in the schedule table on the specification represent a 25 psi increase above the minimum. These pressures shall not be exceeded at any location in the piping system. Valves, instruments, fittings and other components may have additional pressure limitations and may require isolation for the test pressure.
- 48 Installation, examination and testing shall be per AWWA C600.

Section REF References

Rev. 0, 9/17/2014

REF-3 ASME B31.3 Process Piping Guide

- 49 Cement-mortar lining per AWWA C104/A21.4 is acceptable
- 50 Flanges and flanged joints identified in this specification have bolt patterns identical to ASME B16.1 Class 125 flanges. However, B16.1 flanges are not rated for the design pressures allowed herein.

Section REF References

Rev. 0, 9/17/2014

REF-3 ASME B31.3 Process Piping Guide

Piping Specification 101	Date: September 17, 2014	Revision: 0	Page 1 of 1
--------------------------	--------------------------	-------------	-------------

DESIGN PARAMETERS

P-Spec	PS-101(A, B, C, D)						
Design Pressure (psig)	285	260	230	200	170	140	125
Design Temperature (°F)	100	200	300	400	500	600	650
Minimum Temperature (°F)	-20	-20	-20	-20	-20	-20	-20
Minimum Test Pressure (psig)	430	390	345	300	270	245	220
Maximum Test Pressure (psig)	820						

Calculation Reference:	00-00-CALC-M-0004-R0
Code of Reference:	B31.3 - 2002
Fluid Service:	Normal
Material:	Carbon Steel
Pressure Rating:	Class 150
External Pressure Rating:	15 psi

GENERAL NOTES

Refer to General Notes 1-12.

ALLOWABLE PIPE MATERIALS

Component	Size	Rating	Standard	Material	Material Grade	Additional Requirements
Piping	¼ - 24	Schedule Tables	ASME B36.10M	ASTM A53	B	ERW – Type E/Seamless
Piping	¼ - 24	Schedule Tables	ASME B36.10	ASTM A106	B	Seamless

REQUIRED SCHEDULES FOR NON-THREADED PIPE

P-Spec	Corrosion Allowance	Pipe Size	¼	½	¾	1	1 ½	2	2 ½	3	4	6	8	10	12	14	16	18	20	24	
A	0.000	Schedule	STD	STD	STD	STD	STD	STD	STD	STD	STD	STD	STD	STD	STD	STD	STD	STD	STD	STD	STD
B	0.031	Schedule	STD	STD	STD	STD	STD	STD	STD	STD	STD	STD	STD	STD	STD	STD	STD	STD	STD	STD	STD
C	0.063	Schedule	80	STD	STD	STD	STD	STD	STD	STD	STD	STD	STD	STD	STD	STD	STD	STD	STD	STD	STD
D	0.125	Schedule	-	XXS	160	160	160	80	80	80	STD	STD	STD	STD	STD	STD	STD	STD	STD	STD	STD

REQUIRED SCHEDULES FOR THREADED PIPE

P-Spec	Corrosion Allowance	Pipe Size	¼	½	¾	1	1 ½	2	2 ½	3	4	6
A	0.000	Schedule	80	80	80	80	80	STD	STD	STD	STD	STD
B	0.031	Schedule	80	80	80	80	80	STD	STD	STD	STD	STD
C	0.063	Schedule	-	80	80	80	80	80	80	80	STD	STD
D	0.125	Schedule	-	XXS	160	160	160	160	160	80	80	80

FITTINGS

Component	Size	Rating	Standard	Material	Material Grade	Additional Requirements
Threaded Fittings	¼ - 4	2000#, 3000#	ASME B16.11	ASTM A105	WP	Use 3000# for PS101-D
Socket-Weld Fittings	¼ - 2	3000#, 6000#	ASME B16.11	ASTM A105	WP	Use 6000# for PS101-D
Buttweld Fittings	½ - 24	Schedule Tables	ASME B16.9	ASTM A234	WPB	
Buttweld Fittings	½ - 24	Schedule Tables	ASME B16.28	ASTM A234	WPB	

FLANGES

Component	Size	Rating	Standard	Material	Material Grade	Additional Requirements
Threaded Flange	½ - 6	Class 150	ASME B16.5	ASTM A105	N/A	
Socket-Weld Flange	½ - 2	Class 150	ASME B16.5	ASTM A105	N/A	
Weldneck Flange	½ - 24	Class 150	ASME B16.5	ASTM A105	N/A	
Slip-on Flange	½ - 24	Class 150	ASME B16.5	ASTM A105	N/A	
Blind Flange	½ - 24	Class 150	ASME B16.5	ASTM A105	N/A	
Backup Flange	½ - 24	Class 150	ASME B16.5	ASTM A105	N/A	

MECHANICAL FASTENERS

Component	Size	Standard	Material	Material Grade	Additional Requirements
Fasteners	½ - 1 ¼	ASME B18.2.1	ASTM A193	B7-HH	See General Note 10.
Nuts	½ - 1 ¼	ASME B18.2.2	ASTM A194	2H-HH	

Section REF References

Rev. 0, 9/17/2014

REF-3 ASME B31.3 Process Piping Guide

Piping Specification 102	Date: September 17, 2014	Revision: 0	Page 1 of 1
--------------------------	--------------------------	-------------	-------------

DESIGN PARAMETERS

P-Spec	PS-102(A, B, C, D)						
Design Pressure (psig)	285	260	225	185	-	-	-
Design Temperature (°F)	100	200	250	300	-	-	-
Minimum Temperature (°F)	-20	-20	-20	-20	-	-	-
Minimum Test Pressure (psig)	430	390	340	280	-	-	-
Maximum Test Pressure (psig)	820						

Calculation Reference:	00-00-CALC-M-0004-R0
Code of Reference:	B31.3 - 2002
Fluid Service:	Normal
Material:	Carbon Steel
Pressure Rating:	Class 150 per B16.3
External Pressure Rating:	15 psi

GENERAL NOTES

Refer to General Notes 1-12.

ALLOWABLE PIPE MATERIALS

Component	Size	Rating	Standard	Material	Material Grade	Additional Requirements
Piping	¼ - 24	Schedule Tables	ASME B36.10	ASTM A53	B	ERW/Seamless
Piping	¼ - 24	Schedule Tables	ASME B36.10	ASTM A106	B	Seamless

REQUIRED SCHEDULES FOR NON-THREADED PIPE

P-Spec	Corrosion Allowance	Pipe Size	¼	½	¾	1	1½	2	2½	3	4	6	8	10	12	14	16	18	20	24	
A	0.000	Schedule	STD	STD	STD	STD	STD	STD	STD	STD	STD	STD	STD	STD	STD	STD	STD	STD	STD	STD	STD
B	0.031	Schedule	STD	STD	STD	STD	STD	STD	STD	STD	STD	STD	STD	STD	STD	STD	STD	STD	STD	STD	STD
C	0.062	Schedule	80	STD	STD	STD	STD	STD	STD	STD	STD	STD	STD	STD	STD	STD	STD	STD	STD	STD	STD
D	0.125	Schedule	-	-	160	160	160	80	80	80	STD	STD	STD	STD	STD	STD	STD	STD	STD	STD	STD

REQUIRED SCHEDULES FOR THREADED PIPE

P-Spec	Corrosion Allowance	Pipe Size	¼	½	¾	1	1½	2	2½	3	4	6
A	0.000	Schedule	80	80	80	80	80	STD	STD	STD	STD	STD
B	0.031	Schedule	80	80	80	80	80	STD	STD	STD	STD	STD
C	0.063	Schedule	-	80	80	80	80	80	80	80	STD	STD
D	0.125	Schedule	-	-	160	160	160	160	160	80	80	80

FITTINGS

Component	Size	Rating	Standard	Material	Material Grade	Additional Requirements
Threaded Fittings	¼ - 4	2000#, 3000#	ASME B16.11	ASTM A105	WP	Use 3000# for PS102-D
Threaded Fittings	¼ - 6	Class 150	ASME B16.3	ASTM A197	N/A	Malleable Iron, Not allowed in PS102-D
Threaded Fittings	¼ - 4	Class 150	ASME B16.39	ASTM A197	N/A	Malleable Iron, Not allowed in PS102-D
Socket-Weld Fittings	¼ - 2	3000#	ASME B16.11	ASTM A105	WP	Not allowed in PS102-D
Buttweld Fittings	½ - 24	Schedule Tables	ASME B16.9	ASTM A234	WPB	
Buttweld Fittings	½ - 24	Schedule Tables	ASME B16.28	ASTM A234	WPB	

FLANGES

Component	Size	Rating	Standard	Material	Material Grade	Additional Requirements
Threaded Flange	½ - 6	Class 150	ASME B16.5	ASTM A105	N/A	Limited to 2" and larger is PS102-D
Socket-Weld Flange	½ - 2	Class 150	ASME B16.5	ASTM A105	N/A	Not allowed in PS102-D
Weldneck Flange	½ - 24	Class 150	ASME B16.5	ASTM A105	N/A	
Slip-on Flange	½ - 24	Class 150	ASME B16.5	ASTM A105	N/A	
Blind Flange	½ - 24	Class 150	ASME B16.5	ASTM A105	N/A	
Backup Flange	½ - 24	Class 150	ASME B16.5	ASTM A105	N/A	

MECHANICAL FASTENERS

Component	Size	Standard	Material	Material Grade	Additional Requirements
Fasteners	½ - 1 ¼	ASME B18.2.1	ASTM A193	B7-HH	See General Note 10.
Nuts	½ - 1 ¼	ASME B18.2.2	ASTM A194	2H-HH	

Section REF References

Rev. 0, 9/17/2014

REF-3 ASME B31.3 Process Piping Guide

Piping Specification 103	Date: September 17, 2014	Revision: 0	Page 1 of 1
--------------------------	--------------------------	-------------	-------------

DESIGN PARAMETERS

P-Spec	PS-103 (A, B, C, D)						
Design Pressure (psig)	740	675	655	635	600	550	535
Design Temperature (°F)	100	200	300	400	500	600	650
Minimum Temperature (°F)	-20	-20	-20	-20	-20	-20	-20
Minimum Test Pressure (psig)	1110	1015	985	955	950	955	945
Maximum Test Pressure (psig)	1320						

Calculation Reference:	00-00-CALC-M-0004-R0
Code of Reference:	B31.3 - 2002
Fluid Service:	Normal
Material:	Carbon Steel
Pressure Rating:	Class 300
External Pressure Rating:	15 psi

GENERAL NOTES

Refer to General Notes 1-12.

ALLOWABLE PIPE MATERIALS

Component	Size	Rating	Standard	Material	Material Grade	Additional Requirements
Piping	¼ - 24	Schedule Tables	ASME B36.10	ASTM A53	B	Welded/Seamless
Piping	¼ - 24	Schedule Tables	ASME B36.10	ASTM A106	B	Seamless

REQUIRED SCHEDULES FOR NON-THREADED PIPE

P-Spec	Corrosion Allowance	Pipe Size	Pipe Size																			
			¼	½	¾	1	1½	2	2½	3	4	6	8	10	12	14	16	18	20	24		
A	0.000	Schedule	STD	STD	STD	STD	STD	STD	STD	STD	STD	STD	STD	STD	STD	STD	STD	40	XS	40	40	
B	0.031	Schedule	STD	STD	STD	STD	STD	STD	STD	STD	STD	STD	STD	STD	STD	STD	STD	40	40	XS	40	40
C	0.063	Schedule	80	80	80	STD	80	80	STD	STD	STD	80	STD	STD	40	40	40	40	40	40	40	40
D	0.125	Schedule	-	-	160	160	160	160	80	80	80	80	80	80	XS	XS	80	80	80	80	80	80

REQUIRED SCHEDULES FOR THREADED PIPE

P-Spec	Corrosion Allowance	Pipe Size	Pipe Size									
			¼	½	¾	1	1½	2	2½	3	4	6
A	0.000	Schedule	80	80	80	80	80	STD	STD	STD	STD	STD
B	0.031	Schedule	80	80	80	80	80	80	80	80	80	80
C	0.063	Schedule	-	160	160	160	80	80	80	80	80	80
D	0.125	Schedule	-	-	-	-	160	160	160	160	120	80

FITTINGS

Component	Size	Rating	Standard	Material	Material Grade	Additional Requirements
Threaded Fittings	¼ - 4	2000#	ASME B16.11	ASTM A105	WP	
Socket-Weld Fittings	¼ - 2	3000#, 6000#	ASME B16.11	ASTM A105	WP	Use 6000# in PS103-D
Buttweld Fittings	½ - 24	Schedule Tables	ASME B16.9	ASTM A234	WPB	
Buttweld Fittings	½ - 24	Schedule Tables	ASME B16.28	ASTM A234	WPB	

FLANGES

Component	Size	Rating	Standard	Material	Material Grade	Additional Requirements
Threaded Flange	½ - 6	Class 300	ASME B16.5	ASTM A105	N/A	
Socket-Weld Flange	½ - 2	Class 300	ASME B16.5	ASTM A105	N/A	
Weldneck Flange	½ - 24	Class 300	ASME B16.5	ASTM A105	N/A	
Slip-on Flange	½ - 24	Class 300	ASME B16.5	ASTM A105	N/A	
Blind Flange	½ - 24	Class 300	ASME B16.5	ASTM A105	N/A	
Backup Flange	½ - 24	Class 300	ASME B16.5	ASTM A105	N/A	

MECHANICAL FASTENERS

Component	Size	Standard	Material	Material Grade	Additional Requirements
Fasteners	½ - 1 ¼	ASME B18.2.1	ASTM A193	B7-HH	Min. Temp. = 50°F, See General Note 10
Nuts	½ - 1 ¼	ASME B18.2.2	ASTM A194	2H-HH	

Section REF References
REF-3 ASME B31.3 Process Piping Guide

Rev. 0, 9/17/2014

Piping Specification 104	Date: September 17, 2014	Revision: 0	Page 1 of 1
--------------------------	--------------------------	-------------	-------------

DESIGN PARAMETERS

P-Spec	PS-104(A, B, C, D)						
Design Pressure (psig)	990	900	875	845	800	730	715
Design Temperature (°F)	100	200	300	400	500	600	650
Minimum Temperature (°F)	-20	-20	-20	-20	-20	-20	-20
Minimum Test Pressure (psig)	1485	1355	1315	1270	1270	1265	1260
Maximum Test Pressure (psig)	1775						

Calculation Reference:	00-00-CALC-M-0004-R0
Code of Reference:	B31.3 - 2002
Fluid Service:	Normal
Material:	Carbon Steel
Pressure Rating:	Class 400
External Pressure Rating:	15 psi

GENERAL NOTES

Refer to General Notes 1-12.

ALLOWABLE PIPE MATERIALS

Component	Size	Rating	Standard	Material	Material Grade	Additional Requirements
Piping	¼ - 24	Schedule Tables	ASME B36.10	ASTM A53	B	Welded/Seamless
Piping	¼ - 24	Schedule Tables	ASME B36.10	ASTM A106	B	Seamless

REQUIRED SCHEDULES FOR NON-THREADED PIPE

P-Spec	Corrosion Allowance	Pipe Size	¼	½	¾	1	1½	2	2½	3	4	6	8	10	12	14	16	18	20	24	
A	0.00	Schedule	STD	STD	STD	STD	STD	STD	STD	STD	STD	STD	STD	STD	STD	XS	XS	80	80	80	80
B	0.03	Schedule	STD	STD	STD	STD	STD	STD	STD	STD	STD	80	STD	80	XS	XS	80	80	80	80	
C	0.05	Schedule	80	80	80	80	80	80	80	80	80	80	80	80	XS	80	80	80	80	80	
D	0.07	Schedule	-	-	-	160	160	160	160	160	120	120	80	80	80	80	80	80	80	80	

REQUIRED SCHEDULES FOR THREADED PIPE

P-Spec	Corrosion Allowance	Pipe Size	¼	½	¾	1	1½	2	2½	3	4	6
A	0.00	Schedule	80	80	80	80	80	80	80	80	80	80
B	0.03	Schedule	80	80	80	80	80	80	80	80	80	80
C	0.05	Schedule	-	160	160	160	160	160	160	160	80	80
D	0.07	Schedule	-	-	-	-	-	160	160	160	120	120

FITTINGS

Component	Size	Rating	Standard	Material	Material Grade	Additional Requirements
Threaded Fittings	¼ - 4	2000#, 3000#	ASME B16.11	ASTM A105	WP	2000# only where pipe is ≤ Sch. 80
Socket-Weld Fittings	¼ - 2	3000#	ASME B16.11	ASTM A105	WP	
Buttweld Fittings	½ - 24	Schedule Tables	ASME B16.9	ASTM A234	WPB	
Buttweld Fittings	½ - 24	Schedule Tables	ASME B16.28	ASTM A234	WPB	

FLANGES

Component	Size	Rating	Standard	Material	Material Grade	Additional Requirements
Threaded Flange	½ - 6	Class 400/600	ASME B16.5	ASTM A105	N/A	Class 600 required for sizes ½ - 3
Socket-Weld Flange	½ - 2	Class 600	ASME B16.5	ASTM A105	N/A	
Weldneck Flange	½ - 24	Class 400/600	ASME B16.5	ASTM A105	N/A	Class 600 required for sizes ½ - 3
Slip-on Flange	½ - 24	Class 400/600	ASME B16.5	ASTM A105	N/A	Class 600 required for sizes ½ - 3
Blind Flange	½ - 24	Class 400/600	ASME B16.5	ASTM A105	N/A	Class 600 required for sizes ½ - 3
Backup Flange	½ - 24	Class 400/600	ASME B16.5	ASTM A105	N/A	Class 600 required for sizes ½ - 3

MECHANICAL FASTENERS

Component	Size	Standard	Material	Material Grade	Additional Requirements
Fasteners	½ - 1 ¾	ASME B18.2.1	ASTM A193	B7-HH	See General Note 10
Nuts	½ - 1 ¾	ASME B18.2.2	ASTM A194	2H-HH	

Section REF References

Rev. 0, 9/17/2014

REF-3 ASME B31.3 Process Piping Guide

Piping Specification 105	Date: September 17, 2014	Revision: 0	Page 1 of 1
--------------------------	--------------------------	-------------	-------------

DESIGN PARAMETERS

P-Spec	PS-105(A, B, C, D)						
Design Pressure (psig)	1480	1350	1315	1270	1200	1095	1075
Design Temperature (°F)	100	200	300	400	500	600	650
Minimum Temperature (°F)	-20	-20	-20	-20	-20	-20	-20
Minimum Test Pressure (psig)	2220	2025	1975	1905	1905	1900	1900
Maximum Test Pressure (psig)	2625						

Calculation Reference:	00-00-CALC-M-0004-R0
Code of Reference:	B31.3 - 2002
Fluid Service:	Normal
Material:	Carbon Steel
Pressure Rating:	Class 600
External Pressure Rating:	15 psi

GENERAL NOTES

Refer to General Notes 1-12.

ALLOWABLE PIPE MATERIALS

Component	Size	Rating	Standard	Material	Material Grade	Additional Requirements
Piping	¼ - 24	Schedule Tables	ASME B36.10	ASTM A53	B	Welded/Seamless
Piping	¼ - 24	Schedule Tables	ASME B36.10	ASTM A106	B	Seamless

REQUIRED SCHEDULES FOR NON-THREADED PIPE

P-Spec	Corrosion Allowance	Pipe Size	Pipe Schedules																		
			¼	½	¾	1	1½	2	2½	3	4	6	8	10	12	14	16	18	20	24	
A	0.000	Schedule	STD	STD	STD	STD	STD	STD	STD	STD	80	80	80	80	80	80	80	80	80	80	80
B	0.030	Schedule	STD	STD	STD	STD	80	80	80	80	80	120	80	80	80	80	80	80	80	80	80
C	0.050	Schedule	80	80	80	80	80	80	80	80	120	120	80	80	80	80	80	80	80	80	80
D	0.070	Schedule	-	160	160	160	160	160	160	160	120	120	80	120	120	120	120	120	120	120	120

REQUIRED SCHEDULES FOR THREADED PIPE

P-Spec	Corrosion Allowance	Pipe Size	Pipe Schedules									
			¼	½	¾	1	1½	2	2½	3	4	6
A	0.000	Schedule	80	80	80	80	80	80	80	80	120	
B	0.030	Schedule	80	80	80	80	160	160	160	160	120	120
C	0.050	Schedule	-	160	160	160	160	160	160	160	120	120
D	0.070	Schedule	-	160	160	160	160	160	160	160	120	120

FITTINGS

Component	Size	Rating	Standard	Material	Material Grade	Additional Requirements
Threaded Fittings	¼ - 4	2000#, 3000#	ASME B16.11	ASTM A105	WP	2000# only where pipe is ≤ Sch. 80
Socket-Weld Fittings	¼ - 2	3000#, 6000#	ASME B16.11	ASTM A105	WP	3000# only where pipe is ≤ Sch. 80
Buttweld Fittings	½ - 24	Schedule Tables	ASME B16.9	ASTM A234	WPB	
Buttweld Fittings	½ - 24	Schedule Tables	ASME B16.28	ASTM A234	WPB	

FLANGES

Component	Size	Rating	Standard	Material	Material Grade	Additional Requirements
Threaded Flange	½ - 6	Class 600	ASME B16.5	ASTM A105	N/A	
Socket-Weld Flange	½ - 2	Class 600	ASME B16.5	ASTM A105	N/A	
Weldneck Flange	½ - 24	Class 600	ASME B16.5	ASTM A105	N/A	
Slip-on Flange	½ - 24	Class 600	ASME B16.5	ASTM A105	N/A	
Blind Flange	½ - 24	Class 600	ASME B16.5	ASTM A105	N/A	
Backup Flange	½ - 24	Class 600	ASME B16.5	ASTM A105	N/A	

MECHANICAL FASTENERS

Component	Size	Standard	Material	Material Grade	Additional Requirements
Fasteners	½ - 1 ¾	ASME B18.2.1	ASTM A193	B7-HH	See General Note 10
Nuts	½ - 1 ¾	ASME B18.2.2	ASTM A194	2H-HH	

Piping Specification 106	Date: September 17, 2014	Revision: 0	Page 1 of 1
--------------------------	--------------------------	-------------	-------------

DESIGN PARAMETERS

P-Spec	PS-106(A, B, C, D)						
Design Pressure (psig)	1000	855	815	645	120	75	50
Design Temperature (°F)	400	600	700	750	1000	1050	1100
Minimum Temperature (°F)	-20	-20	-20	-20	-20	-20	-20
Minimum Test Pressure (psig)	1500	1485	1480	1490	1170	730	490
Maximum Test Pressure (psig)	1790						

Calculation Reference:	00-00-CALC-M-0004-R0
Code of Reference:	B31.3 - 2002
Fluid Service:	Normal
Material:	Carbon Steel
Pressure Rating:	1000 psi
External Pressure Rating:	15 psi

GENERAL NOTES

Refer to General Notes 1-12.

ALLOWABLE PIPE MATERIALS

Component	Size	Rating	Standard	Material	Material Grade	Additional Requirements
Piping	¼ - 6	Schedule Tables	ASME B36.10	ASTM A53	B	Seamless
Piping	¼ - 6	Schedule Tables	ASME B36.10	ASTM A106	B	Seamless

REQUIRED SCHEDULES FOR NON-THREADED PIPE

P-Spec	Corrosion Allowance	Pipe Size	¼	½	¾	1	1½	2	2½	3	4	6
A	0.000	Schedule	STD	STD	STD	STD	STD	STD	STD	STD	STD	STD
B	0.030	Schedule	STD	STD	STD	STD	STD	STD	STD	STD	STD	STD
C	0.050	Schedule	80	STD	STD	STD	STD	80	STD	STD	STD	80

REQUIRED SCHEDULES FOR THREADED PIPE

P-Spec	Corrosion Allowance	Pipe Size	¼	½	¾	1	1½	2	2½	3	4	6
A	0.000	Schedule	80	80	80	80	80	STD	STD	STD	80	80
B	0.030	Schedule	80	80	80	80	80	80	80	80	80	80
C	0.050	Schedule	-	80	80	80	80	80	80	80	80	80

FITTINGS

Component	Size	Rating	Standard	Material	Material Grade	Additional Requirements
Threaded Fittings	¼ - 4	2000#	ASME B16.11	ASTM A105	WP	Only for fit up to threaded components
Socket-Weld Fittings	¼ - 2	3000#	ASME B16.11	ASTM A105	WP	
Buttweld Fittings	½ - 6	Schedule Tables	ASME B16.9	ASTM A234	WPB	
Buttweld Fittings	½ - 6	Schedule Tables	ASME B16.28	ASTM A234	WPB	

FLANGES

Component	Size	Rating	Standard	Material	Material Grade	Additional Requirements
Socket-Weld Flange	½ - 6	Class 600	ASME B16.5	ASTM A105	N/A	limited to 1000°F
Weldneck Flange	½ - 6	Class 600	ASME B16.5	ASTM A105	N/A	limited to 1000°F
Slip-on Flange	½ - 6	Class 600	ASME B16.5	ASTM A105	N/A	limited to 1000°F
Backup Flange	½ - 6	Class 600	ASME B16.5	ASTM A105	N/A	limited to 1000°F

MECHANICAL FASTENERS

Component	Size	Standard	Material	Material Grade	Additional Requirements
Fasteners	½ - 1 ¼	ASME B18.2.1	ASTM A193	B7-HH	See General Note 10
Nuts	½ - 1 ¼	ASME B18.2.2	ASTM A194	2H-HH	

Section REF References

Rev. 0, 9/17/2014

REF-3 ASME B31.3 Process Piping Guide

Piping Specification 107	Date: September 17, 2014	Revision: 0	Page 1 of 1
--------------------------	--------------------------	-------------	-------------

DESIGN PARAMETERS

P-Spec	PS-107(A, B)						
Design Pressure (psig)	3705	3375	3280	3170	2995	2735	2665
Design Temperature (°F)	100	200	300	400	500	600	700
Minimum Temperature (°F)	-20	-20	-20	-20	-20	-20	-20
Minimum Test Pressure (psig)	5560	5065	4920	4755	4755	4745	4845
Maximum Test Pressure (psig)	6505						

Calculation Reference:	00-00-CALC-M-0004-R0
Code of Reference:	B31.3 - 2002
Fluid Service:	Normal
Material:	Carbon Steel
Pressure Rating:	Class 1500
External Pressure Rating:	15 psi

GENERAL NOTES

Refer to General Notes 1-12.

ALLOWABLE PIPE MATERIALS

Component	Size	Rating	Standard	Material	Material Grade	Additional Requirements
Piping	¼ - 6	Schedule Tables	ASME B36.10	ASTM A53	B	Seamless
Piping	¼ - 6	Schedule Tables	ASME B36.10	ASTM A106	B	Seamless

REQUIRED SCHEDULES FOR NON-THREADED PIPE

P-Spec	Corrosion Allowance	Pipe Size	Pipe Size									
			¼	½	¾	1	1½	2	2½	3	4	6
A	0.000	Schedule	STD	STD	80	80	160	160	160	160	XXS	XXS
B	0.030	Schedule	80	160	160	160	XXS	160	XXS	XXS	XXS	-

FITTINGS

Component	Size	Rating	Standard	Material	Material Grade	Additional Requirements
Socket-Weld Fittings	¼ - 2	9000#	ASME B16.11	ASTM A105	WP	
Buttweld Fittings	¼ - 6	see schedule table	ASME B16.9	ASTM A234	WPB	
Buttweld Fittings	¼ - 6	see schedule table	ASME B16.28	ASTM A234	WPB	

FLANGES

Component	Size	Rating	Standard	Material	Material Grade	Additional Requirements
Socket-Weld Flange	½ - 2	Class 1500	ASME B16.5	ASTM A105	N/A	
Weldneck Flange	½ - 6	Class 1500	ASME B16.5	ASTM A105	N/A	
Slip-on Flange	½ - 6	Class 1500	ASME B16.5	ASTM A105	N/A	

MECHANICAL FASTENERS

Component	Size	Standard	Material	Material Grade	Additional Requirements
Fasteners	½ - 1 ¾	ASME B18.2.1	ASTM A193	B7-HH	See General Note 10
Nuts	½ - 1 ¾	ASME B18.2.2	ASTM A194	2H-HH	

Section REF References

Rev. 0, 9/17/2014

REF-3 ASME B31.3 Process Piping Guide

Piping Specification 108	Date: September 17, 2014	Revision: 0	Page 1 of 1
--------------------------	--------------------------	-------------	-------------

DESIGN PARAMETERS

P-Spec	PS-108						
Design Pressure (psig)	6170	5625	5470	5280	4990	4560	4440
Design Temperature (°F)	100	200	300	400	500	600	700
Minimum Temperature (°F)	-20	-20	-20	-20	-20	-20	-20
Minimum Test Pressure (psig)	9255	8440	8205	7920	7920	7910	8075
Maximum Test Pressure (psig)	11,295						

Calculation Reference:	00-00-CALC-M-0004-R0
Code of Reference:	B31.3 - 2002
Fluid Service:	Normal
Material:	Carbon Steel
Pressure Rating:	Class 2500
External Pressure Rating:	15 psi

GENERAL NOTES

Refer to General Notes 1-11, 15.

ALLOWABLE PIPE MATERIALS

Component	Size	Rating	Standard	Material	Material Grade	Additional Requirements
Piping	¼ - 3	Schedule Tables	ASME B36.10	ASTM A53	B	Seamless
Piping	¼ - 3	Schedule Tables	ASME B36.10	ASTM A106	B	Seamless

REQUIRED SCHEDULES FOR NON-THREADED PIPE

P-Spec	Corrosion Allowance	Pipe Size	¼	½	¾	1	1½	2	2½	3
108	0.000	Schedule	80	160	160	160	XXS	XXS	XXS	XXS

FITTINGS

Component	Size	Rating	Standard	Material	Material Grade	Additional Requirements
Socket-Weld Fittings	¼ - 2	9000#	ASME B16.11	ASTM A105	WP	
Buttweld Fittings	½ - 3	Schedule Tables	ASME B16.9	ASTM A234	WPB	
Buttweld Fittings	½ - 3	Schedule Tables	ASME B16.28	ASTM A234	WPB	

FLANGES

Component	Size	Rating	Standard	Material	Material Grade	Additional Requirements
Weldneck Flange	½ - 3	Class 2500	ASME B16.5	ASTM A105	N/A	

MECHANICAL FASTENERS

Component	Size	Standard	Material	Material Grade	Additional Requirements
Fasteners	¾ - 1 ¼	ASME B18.2.1	ASTM A193	B7-HH	See General Note 10
Nuts	¾ - 1 ¼	ASME B18.2.2	ASTM A194	2H-HH	

Section REF References

Rev. 0, 9/17/2014

REF-3 ASME B31.3 Process Piping Guide

Piping Specification 109	Date: September 17, 2014	Revision: 0	Page 1 of 1
--------------------------	--------------------------	-------------	-------------

DESIGN PARAMETERS

P-Spec	PS-109(A, B, C, D)	
Design Pressure (psig)	500	500
Design Temperature (°F)	100	200
Minimum Temperature (°F)	-20	-20
Minimum Test Pressure (psig)	750	750
Maximum Test Pressure (psig)	1810	

Calculation Reference:	00-00-CALC-M-0004-R0
Code of Reference:	B31.3 - 2002
Fluid Service:	Normal
Material:	Carbon Steel
Pressure Rating:	500 psi
External Pressure Rating:	15 psi

GENERAL NOTES

Refer to General Notes 1-12, and 51

ALLOWABLE PIPE MATERIALS

Component	Size	Rating	Standard	Material	Material Grade	Additional Requirements
Piping	¼ - 10	Schedule Tables	ASME B36.10M	ASTM A53	B	ERW – Type E/Seamless
Piping	¼ - 10	Schedule Tables	ASME B36.10	ASTM A106	B	Seamless

REQUIRED SCHEDULES FOR NON-THREADED PIPE

P-Spec	Corrosion Allowance	Pipe Size	¼	½	¾	1	1½	2	2½	3	4	6	8	10
A	0.000	Schedule	40	40	40	40	40	40	40	40	40	40	40	40
B	0.031	Schedule	40	40	40	40	40	40	40	40	40	40	40	40
C	0.063	Schedule	80	80	80	40	40	40	40	40	40	40	40	40

REQUIRED SCHEDULES FOR THREADED PIPE

P-Spec	Corrosion Allowance	Pipe Size	¼	½	¾	1	1½	2	2½	3	4	6
A	0.000	Schedule	80	80	80	80	80	40	40	40	40	40
B	0.031	Schedule	80	80	80	80	80	80	80	80	80	80
C	0.063	Schedule	-	160	160	160	80	80	80	80	80	80

FITTINGS

Component	Size	Rating	Standard	Material	Material Grade	Additional Requirements
Victaulic Zero-Flex Coupling 07	1 - 10	Manufacturer's	Manufacturer's	Manufacturer's	Manufacturer's	Use with EPDM gasket, Min Temp 20° F.
Threaded Fittings	¼ - 4	2000#	ASME B16.11	ASTM A105	WP	
Socket-Weld Fittings	¼ - 2	3000#	ASME B16.11	ASTM A105	WP	
Buttweld Fittings	½ - 10	Schedule Tables	ASME B16.9	ASTM A234	WPB	
Buttweld Fittings	½ - 10	Schedule Tables	ASME B16.28	ASTM A234	WPB	

FLANGES

Component	Size	Rating	Standard	Material	Material Grade	Additional Requirements
Threaded Flanges	½ - 6	Class 300	ASME B16.5	ASTM A105	N/A	
Socket-Weld Flange	½ - 2	Class 300	ASME B16.5	ASTM A105	N/A	
Weldneck Flange	½ - 10	Class 300	ASME B16.5	ASTM A105	N/A	
Slip-on Flange	½ - 10	Class 300	ASME B16.5	ASTM A105	N/A	
Blind Flange	½ - 10	Class 300	ASME B16.5	ASTM A105	N/A	
Backup Flange	½ - 10	Class 300	ASME B16.5	ASTM A105	N/A	

MECHANICAL FASTENERS

Component	Size	Standard	Material	Material Grade	Additional Requirements
Fasteners	½ - 1	ASME B18.2.1	ASTM A193	B7-HH	See General Note 10. Not for use with Victaulic Fittings
Nuts	½ - 1	ASME B18.2.2	ASTM A194	2H-HH	Not for use with Victaulic Fittings

Section REF References
REF-3 ASME B31.3 Process Piping Guide

Rev. 0, 9/17/2014

Piping Specification 200	Date: September 17, 2014	Revision: 0	Page 1 of 1
--------------------------	--------------------------	-------------	-------------

DESIGN PARAMETERS

P-Spec	PS-200(A, B, C, D)						
Design Pressure (psig)	230	195	175	160	145	140	125
Design Temperature (°F)	100	200	300	400	500	600	650
Minimum Temperature (°F)	-425	-425	-425	-425	-425	-425	-425
Minimum Test Pressure (psig)	345	295	265	255	245	250	230
Maximum Test Pressure (psig)	440 for NPS ≤ 6, 360 for NPS > 6						

Calculation Reference:	00-00-CALC-M-0004-R0
Code of Reference:	B31.3 - 2002
Fluid Service:	Normal
Material:	Stainless Steel (304L)
Pressure Rating:	Class 150
External Pressure Rating:	15 psi

GENERAL NOTES

Refer to General Notes 1-12, 16.

ALLOWABLE PIPE MATERIALS

Component	Size	Rating	Standard	Material	Material Grade	Additional Requirements
Piping	¼ - 24	Schedule Tables	ASME B36.19	ASTM A312	TP316L	Welded
Piping	¼ - 24	Schedule Tables	ASME B36.19	ASTM A312	TP316L	Seamless

REQUIRED SCHEDULES FOR NON-THREADED PIPE

P-Spec	Corrosion Allowance	Pipe Size	Pipe Schedules																		
			¼	½	¾	1	1½	2	2½	3	4	6	8	10	12	14	16	18	20	24	
A	0.00	Schedule	10S	10S	10S	10S	10S	10S	10S	10S	10S	10S	10S	10S	10S	10S	10S	10S	10S	10S	
B	0.03	Schedule	10S	10S	10S	10S	10S	10S	10S	10S	10S	10S	10S	10S	10S	10S	10S	-	-	-	-
C	0.05	Schedule	40S	10S	40S	10S	10S	10S	10S	10S	40S	40S	10S	10S	40S	-	-	-	-	-	
D	0.08	Schedule	-	80S	80S	40S	40S	40S	40S	40S	40S	40S	40S	40S	40S	-	-	-	-	-	

REQUIRED SCHEDULES FOR THREADED PIPE

P-Spec	Corrosion Allowance	Pipe Size	Pipe Schedules									
			¼	½	¾	1	1½	2	2½	3	4	6
A	0.00	Schedule	40S	40S	40S	40S	40S	40S	40S	40S	40S	40S
B	0.03	Schedule	80S	40S	40S	40S	40S	40S	40S	40S	40S	40S
C	0.05	Schedule	80S	80S	80S	80S	80S	80S	40S	40S	40S	40S
D	0.08	Schedule	-	-	-	-	80S	80S	80S	80S	80S	40S

FITTINGS

Component	Size	Rating	Standard	Material	Material Grade	Additional Requirements
Threaded Fittings	¼ - 4	2000#	ASME B16.11	ASTM A182	F304L	
Socket-Weld Fittings	¼ - 2	3000#	ASME B16.11	ASTM A182	F304L	
Buttweld Fittings	½ - 24	Schedule Tables	ASME B16.9	ASTM A403	WP304L	
Buttweld Fittings	½ - 24	Schedule Tables	ASME B16.28	ASTM A403	WP304L	

FLANGES

Component	Size	Rating	Standard	Material	Material Grade	Additional Requirements
Threaded Flange	½ - 6	Class 150	ASME B16.5	ASTM A182	F304L	
Socket-Weld Flange	½ - 2	Class 150	ASME B16.5	ASTM A182	F304L	
Weldneck Flange	½ - 24	Class 150	ASME B16.5	ASTM A182	F304L	
Slip-on Flange	½ - 24	Class 150	ASME B16.5	ASTM A182	F304L	
Blind Flange	½ - 24	Class 150	ASME B16.5	ASTM A182	F304L	
Backup Flange	½ - 24	Class 150	ASME B16.5	ASTM A105	N/A	Min Temperature - 20°F. Note 69. See note 8
Backup Flange	½ - 24	Class 150	ASME B16.42	ASTM A395	N/A	Min Temp. - 20°F, Max. Temp. 650°F See note 8.

MECHANICAL FASTENERS

Component	Size	Standard	Material	Material Grade	Additional Requirements
Fasteners	½ - 1 ¼	ASME B18.2.1	ASTM A193	B8 Cl. 2-HH	Min Temperature - 325°F, See Note 10
Nuts	½ - 1 ¼	ASME B18.2.2	ASTM A194	8F-HH	

Section REF References

Rev. 0, 9/17/2014

REF-3 ASME B31.3 Process Piping Guide

Piping Specification 201	Date: September 17, 2014	Revision: 0	Page 1 of 1
--------------------------	--------------------------	-------------	-------------

DESIGN PARAMETERS

P-Spec	PS-201(A, B, C, D)						
Design Pressure (psig)	230	195	175	160	145	140	125
Design Temperature (°F)	100	200	300	400	500	600	650
Minimum Temperature (°F)	-425	-425	-425	-425	-425	-425	-425
Minimum Test Pressure (psig)	345	295	265	255	250	255	230
Maximum Test Pressure (psig)	440 for NPS ≤ 6, 360 for NPS > 6						

Calculation Reference:	00-00-CALC-M-0004-R0
Code of Reference:	B31.3 - 2002
Fluid Service:	Normal
Material:	Stainless Steel (316L)
Pressure Rating:	Class 150
External Pressure Rating:	15 psi

GENERAL NOTES

Refer to General Notes 1-12, 16.

ALLOWABLE PIPE MATERIALS

Component	Size	Rating	Standard	Material	Material Grade	Additional Requirements
Piping	¼ - 24	Schedule Tables	ASME B36.19	ASTM A312	TP316L	Welded
Piping	¼ - 24	Schedule Tables	ASME B36.19	ASTM A312	TP316L	Seamless

REQUIRED SCHEDULES FOR NON-THREADED PIPE

P-Spec	Corrosion Allowance	Pipe Size	¼	½	¾	1	1 ½	2	2 ½	3	4	6	8	10	12	14	16	18	20	24
A	0.00	Schedule	10S	10S	10S	10S	10S	10S	10S	10S	10S	10S	10S	10S	10S	10S	10S	10S	10S	10S
B	0.03	Schedule	10S	10S	10S	10S	10S	10S	10S	10S	10S	10S	10S	10S	10S	10S	-	-	-	-
C	0.05	Schedule	40S	10S	40S	10S	10S	10S	10S	10S	40S	40S	10S	10S	40S	-	-	-	-	-
D	0.08	Schedule	-	80S	80S	40S	40S	40S	40S	40S	40S	40S	40S	40S	40S	-	-	-	-	-

REQUIRED SCHEDULES FOR THREADED PIPE

P-Spec	Corrosion Allowance	Pipe Size	¼	½	¾	1	1 ½	2	2 ½	3	4	6
A	0.00	Schedule	40S	40S	40S	40S	40S	40S	40S	40S	40S	40S
B	0.03	Schedule	80S	80S	40S	40S	40S	40S	40S	40S	40S	40S
C	0.05	Schedule	80S	80S	80S	80S	80S	80S	40S	40S	40S	40S
D	0.08	Schedule	-	-	-	80S	80S	80S	80S	80S	80S	40S

FITTINGS

Component	Size	Rating	Standard	Material	Material Grade	Additional Requirements
Threaded Fittings	¼ - 4	2000#	ASME B16.11	ASTM A182	F316L	
Socket-Weld Fittings	¼ - 2	3000#	ASME B16.11	ASTM A182	F316L	
Buttweld Fittings	½ - 24	Schedule Tables	ASME B16.9	ASTM A403	WP316L	
Buttweld Fittings	½ - 24	Schedule Tables	ASME B16.28	ASTM A403	WP316L	

FLANGES

Component	Size	Rating	Standard	Material	Material Grade	Additional Requirements
Threaded Flange	½ - 6	Class 150	ASME B16.5	ASTM A182	F316L	
Socket-Weld Flange	½ - 2	Class 150	ASME B16.5	ASTM A182	F316L	
Weldneck Flange	½ - 24	Class 150	ASME B16.5	ASTM A182	F316L	
Slip-on Flange	½ - 24	Class 150	ASME B16.5	ASTM A182	F316L	
Blind Flange	½ - 24	Class 150	ASME B16.5	ASTM A182	F316L	
Backup Flange	½ - 24	Class 150	ASME B16.5	ASTM A105	N/A	Min Temperature - 20°F. See note 8
Backup Flange	½ - 24	Class 150	ASME B16.42	ASTM A395	N/A	Min Temp. - 20°F, Max. Temp. 650°F. See note 8

MECHANICAL FASTENERS

Component	Size	Standard	Material	Material Grade	Additional Requirements
Fasteners	½ - 1 ¼	ASME B18.2.1	ASTM A193	B8 Cl. 2-HH	Min Temperature - 325°F, See Note 10
Nuts	½ - 1 ¼	ASME B18.2.2	ASTM A194	8F-HH	

Section REF References

Rev. 0, 9/17/2014

REF-3 ASME B31.3 Process Piping Guide

Piping Specification 202	Date: September 17, 2014	Revision: 0	Page 1 of 2
--------------------------	--------------------------	-------------	-------------

DESIGN PARAMETERS

P-Spec	PS-202(A, B, C, D)						
Design Pressure (psig)	600	505	455	415	380	360	350
Design Temperature (°F)	100	200	300	400	500	600	650
Minimum Temperature (°F)	-425	-425	-425	-425	-425	-425	-425
Minimum Test Pressure (psig)	900	760	680	660	645	645	640
Maximum Test Pressure (psig)	935						

Calculation Reference:	00-00-CALC-M-0004-R0
Code of Reference:	B31.3 - 2002
Fluid Service:	Normal
Material:	Stainless Steel (304L)
Pressure Rating:	Class 300
External Pressure Rating:	15 psi

GENERAL NOTES

Refer to General Notes 1-12, 16.

ALLOWABLE PIPE MATERIALS

Component	Size	Rating	Standard	Material	Material Grade	Additional Requirements
Piping	¼ - 12	Schedule Tables	ASME B36.19	ASTM A312	TP 304L	Welded
Piping	¼ - 12	Schedule Tables	ASME B36.19	ASTM A312	TP 304L	Seamless

REQUIRED SCHEDULES FOR NON-THREADED PIPE

P-Spec	Corrosion Allowance	Pipe Size	Pipe Schedules												
			¼	½	¾	1	1½	2	2½	3	4	6	8	10	12
A	0.00	Schedule	10S	10S	10S	10S	10S	10S	10S	10S	40S	40S	40S	40S	40S
B	0.03	Schedule	10S	10S	10S	10S	10S	40S	40S	40S	40S	40S	40S	40S	40S
C	0.05	Schedule	80S	40S	40S	40S	40S	40S	40S	40S	40S	80S	40S	40S	80S
D	0.08	Schedule	-	80S	80S	80S	80S	80S	80S	80S	80S	80S	40S	40S	80S

REQUIRED SCHEDULES FOR THREADED PIPE

P-Spec	Corrosion Allowance	Pipe Size	Pipe Schedules									
			¼	½	¾	1	1½	2	2½	3	4	6
A	0.00	Schedule	40S	40S	40S	40S	40S	40S	40S	40S	40S	80S
B	0.03	Schedule	80S	80S	80S	80S	80S	80S	80S	80S	80S	80S
C	0.05	Schedule	-	80S	80S	80S	80S	80S	80S	80S	80S	80S
D	0.08	Schedule	-	-	-	-	-	-	-	80S	80S	80S

FITTINGS

Component	Size	Rating	Standard	Material	Material Grade	Additional Requirements
Socket-Weld Fittings	¼ - 2	3000#	ASME B16.11	ASTM A182	F304L	
Threaded Fittings	¼ - 4	2000#	ASME B16.11	ASTM A132	F304L	
Buttweld Fittings	½ - 12	Schedule Tables	ASME B16.9	ASTM A403	WP304L	
Buttweld Fittings	½ - 12	Schedule Tables	ASME B16.28	ASTM A403	WP304L	

FLANGES

Component	Size	Rating	Standard	Material	Material Grade	Additional Requirements
Socket-Weld Flange	½ - 2	Class 300	ASME B16.5	ASTM A182	F304L	
Weldneck Flange	½ - 12	Class 300	ASME B16.5	ASTM A182	F304L	
Slip-on Flange	½ - 12	Class 300	ASME B16.5	ASTM A182	F304L	
Blind Flange	½ - 12	Class 300	ASME B16.5	ASTM A182	F304L	
Threaded Flange	½ - 6	Class 300	ASME B16.5	ASTM A182	F304L	
Backup Flange	½ - 12	Class 300	ASME B16.5	ASTM A105	N/A	Min Temperature - 20°F, See note 8
Backup Flange	½ - 12	Class 300	ASME B16.42	ASTM A395	N/A	Min Temp. - 20°F, Max. Temp. 650°F. See note 8

MECHANICAL FASTENERS

Component	Size	Standard	Material	Material Grade	Additional Requirements
Fasteners	½ - 1 ½	ASME B18.2.1	ASTM A193	B8 Cl. 2-HH	Min Temperature - 325°F, See Note 10
Nuts	½ - 1 ½	ASME B18.2.2	ASTM A194	8F-HH	

Section REF References

Rev. 0, 9/17/2014

REF-3 ASME B31.3 Process Piping Guide

Piping Specification 203	Date: September 17, 2014	Revision: 0	Page 1 of 2
--------------------------	--------------------------	-------------	-------------

DESIGN PARAMETERS

P-Spec	PS-203(A, B, C, D)						
Design Pressure (psig)	600	505	455	415	380	360	350
Design Temperature (°F)	100	200	300	400	500	600	650
Minimum Temperature (°F)	-425	-425	-425	-425	-425	-425	-425
Minimum Test Pressure (psig)	900	760	680	670	660	670	665
Maximum Test Pressure (psig)	935						

Calculation Reference:	00-00-CALC-M-0004-R0
Code of Reference:	B31.3 - 2002
Fluid Service:	Normal
Material:	Stainless Steel (316L)
Pressure Rating:	Class 300
External Pressure Rating:	15 psi

GENERAL NOTES

Refer to General Notes 1-12, 16.

ALLOWABLE PIPE MATERIALS

Component	Size	Rating	Standard	Material	Material Grade	Additional Requirements
Piping	¼ - 12	Schedule Tables	ASME B36.19	ASTM A312	316L	Welded
Piping	¼ - 12	Schedule Tables	ASME B36.19	ASTM A312	316L	Seamless

REQUIRED SCHEDULES FOR NON-THREADED PIPE

P-Spec	Corrosion Allowance	Pipe Size	¼	½	¾	1	1 ½	2	2 ½	3	4	6	8	10	12
A	0.00	Schedule	10S	10S	10S	10S	10S	10S	10S	10S	40S	40S	40S	40S	40S
B	0.03	Schedule	10S	10S	10S	10S	10S	40S	40S	40S	40S	40S	40S	40S	40S
C	0.05	Schedule	80S	40S	40S	40S	40S	40S	40S	40S	40S	80S	40S	40S	80S
D	0.08	Schedule	-	80S	80S	80S	80S	80S	80S	80S	80S	80S	40S	40S	80S

REQUIRED SCHEDULES FOR THREADED PIPE

P-Spec	Corrosion Allowance	Pipe Size	¼	½	¾	1	1 ½	2	2 ½	3	4	6
A	0.00	Schedule	40S	40S	40S	40S	40S	40S	40S	40S	40S	80S
B	0.03	Schedule	80S	80S	80S	80S	80S	80S	80S	80S	80S	80S
C	0.05	Schedule	-	80S	80S	80S	80S	80S	80S	80S	80S	80S
D	0.08	Schedule	-	-	-	-	-	-	-	80S	80S	80S

FITTINGS

Component	Size	Rating	Standard	Material	Material Grade	Additional Requirements
Socket-Weld Fittings	¼ - 2	3000#	ASME B16.11	ASTM A182	F316L	
Threaded Fittings	¼ - 4	2000#	ASME B16.11	ASTM A182	F316L	
Buttweld Fittings	½ - 12	Schedule Tables	ASME B16.9	ASTM A403	WP316L	
Buttweld Fittings	½ - 12	Schedule Tables	ASME B16.28	ASTM A403	WP316L	

FLANGES

Component	Size	Rating	Standard	Material	Material Grade	Additional Requirements
Socket-Weld Flange	½ - 12	Class 300	ASME B16.5	ASTM A182	F316L	
Weldneck Flange	½ - 12	Class 300	ASME B16.5	ASTM A182	F316L	
Slip-on Flange	½ - 12	Class 300	ASME B16.5	ASTM A182	F316L	
Blind Flange	½ - 12	Class 300	ASME B16.5	ASTM A182	F316L	
Threaded Flange	½ - 6	Class 300	ASME B16.5	ASTM A182	F316L	
Backup Flange	½ - 12	Class 300	ASME B16.5	ASTM A105	N/A	Min Temperature - 20°F. See note 8
Backup Flange	½ - 12	Class 300	ASME B16.42	ASTM A395	N/A	Min Temp. - 20°F, Max. Temp. 650°F. See note 8

MECHANICAL FASTENERS

Component	Size	Standard	Material	Material Grade	Additional Requirements
Fasteners	½ - 1 ½	ASME B18.2.1	ASTM A193	B8 Cl. 2-HH	Min Temperature - 325°F, See Note 10
Nuts	½ - 1 ½	ASME B18.2.2	ASTM A194	8F-HH	

Piping Specification 204	Date: September 17, 2014	Revision: 0	Page 1 of 1
--------------------------	--------------------------	-------------	-------------

DESIGN PARAMETERS

P-Spec	PS-204(A, B)							
Design Pressure (psig)	600	600	565	500	465	425	280	
Design Temperature (°F)	100	300	400	600	800	900	1000	
Minimum Temperature (°F)	-425	-425	-425	-425	-425	-425	-425	
Minimum Test Pressure (psig)	900	900	895	895	895	895	900	
Maximum Test Pressure (psig)	1705							

Calculation Reference:	00-00-CALC-M-0004-R0
Code of Reference:	B31.3 -2002
Fluid Service:	Normal
Material:	Stainless Steel (304L)
Pressure Rating:	600 psi
External Pressure Rating:	15 psi

GENERAL NOTES

Refer to General Notes 1-11, 16-18.

ALLOWABLE TUBE MATERIALS

Component	Size	Rating	Standard	Material	Material Grade	Additional Requirements
Tubing	1/16 - 2	Schedule Tables	ASME A269	ASME A269	304L	
Tubing	1/16 - 2	Schedule Tables	ASME A249	ASME A249	304L	

REQUIRED THICKNESS FOR TUBE IN GAS SERVICE:

P-Spec	Corrosion Allowance	Pipe Size	1/8	3/16	1/4	5/16	3/8	1/2	5/8	3/4	7/8	1	1 1/4	1 1/2	2
A	0.00	Thickness	0.028	0.028	0.028	0.035	0.035	0.041	0.052	0.062	0.073	0.083	0.104	0.125	0.167
		Bend Radius	1.5D	1.5D	1.5D	1.5D	1.5D	1.5D	1.5D	1.5D	1.5D	1.5D	1.5D	1.5D	1.5D
B	0.01	Thickness	0.028	0.028	0.028	0.035	0.035	0.049	0.052	0.062	0.073	0.083	0.104	0.125	0.167
		Bend Radius	1.5D	1.5D	1.5D	1.5D	1.5D	1.5D	1.5D	1.5D	1.5D	1.5D	1.5D	1.5D	1.5D

REQUIRED THICKNESS FOR TUBE IN ALL OTHER SERVICES:

P-Spec	Corrosion Allowance	Pipe Size	1/16	1/8	3/16	1/4	5/16	3/8	1/2	5/8	3/4	7/8	1	1 1/4	1 1/2	2
A	0.00	Thickness	0.010	0.028	0.028	0.035	0.035	0.035	0.049	0.049	0.049	0.065	0.065	0.083	0.095	0.109
		Bend Radius	1.5D	1.5D	1.5D	1.5D	1.5D	1.5D	1.5D	1.5D	1.5D	1.5D	1.5D	1.5D	1.5D	1.5D
B	0.01	Thickness	0.020	0.028	0.028	0.035	0.035	0.035	0.049	0.049	0.049	0.065	0.065	0.083	0.095	0.109
		Bend Radius	3D	1.5D	1.5D	1.5D	1.5D	1.5D	1.5D	1.5D	1.5D	1.5D	1.5D	1.5D	1.5D	1.5D

FITTINGS

Component	Size	Rating	Standard	Material	Material Grade	Additional Requirements
Tube Fittings	1/16 - 2	Manufacturer's	Manufacturer's	ASTM A182/A479	316L/304L	Swagelok/Cajon or Parker
Welded Fittings	1/16 - 2	Manufacturer's	Manufacturer's	ASTM A182/A479	316L/304L	Swagelok/Cajon or Parker

Piping Specification 205	Date: September 17, 2014	Revision: 0	Page 1 of 1
--------------------------	--------------------------	-------------	-------------

DESIGN PARAMETERS

P-Spec	PS-205(A, B)							Calculation Reference:	00-00-CALC-M-0004-R0
Design Pressure (psig)	2000	2000	1890	1675	1555	1425	930	Code of Reference:	B31.3 - 2002
Design Temperature (°F)	100	300	400	600	800	900	1000	Fluid Service:	Normal
Minimum Temperature (°F)	-425	-425	-425	-425	-425	-425	-425	Material:	Stainless Steel (304L)
Minimum Test Pressure (psig)	3000	3000	3000	3000	3000	3000	2990	Pressure Rating:	2000 psi
Maximum Test Pressure (psig)	3920							External Pressure Rating:	15 psi

GENERAL NOTES

Refer to General Notes 1-11, 16-18.

ALLOWABLE TUBE MATERIALS

Component	Size	Rating	Standard	Material	Material Grade	Additional Requirements
Tubing	1/16 - 2	Schedule Tables	ASTM A269	ASTM A269	TP 304L	
Tubing	1/16 - 2	Schedule Tables	ASTM A249	ASTM A249	TP 304L	

REQUIRED THICKNESS FOR TUBE

P-Spec	Corrosion Allowance	Pipe Size	1/16	1/8	3/16	1/4	5/16	3/8	1/2	5/8	3/4	7/8	1	1 1/4	1 1/2	2
A	0.00	Thickness	0.014	0.028	0.028	0.035	0.049	0.049	0.065	0.083	0.095	0.095	0.109	0.109	0.120	0.188
		Bend Radius	1.5D	1.5D	1.5D	1.5D	1.5D	1.5D	1.5D	1.5D	1.5D	3D	3D	3D	3D	3D
B	0.01	Thickness	0.020	0.035	0.049	0.049	0.065	0.065	0.083	0.095	0.095	0.095	0.120	0.156	0.188	0.188
		Bend Radius	5D	3D	3D	3D	3D	3D	3D	3D	3D	5D	3D	3D	3D	5D

FITTINGS

Component	Size	Rating	Standard	Material	Material Grade	Additional Requirements
Tube Fittings	1/16 - 2	Manufacturer's	Manufacturer's	ASTM A182/A479	316L/304L	Swagelok/Cajon or Parker
Welded Fittings	1/16 - 2	Manufacturer's	Manufacturer's	ASTM A182/A479	316L/304L	Swagelok/Cajon or Parker

Piping Specification 206	Date: September 17, 2014	Revision: 0	Page 1 of 1
--------------------------	--------------------------	-------------	-------------

DESIGN PARAMETERS

P-Spec	PS-206(A, B)							Calculation Reference:
Design Pressure (psig)	600	600	565	500	465	425	280	00-00-CALC-M-0004-R0
Design Temperature (°F)	100	300	400	600	800	900	1000	Code of Reference: B31.3 - 2002
Minimum Temperature (°F)	-425	-425	-425	-425	-425	-425	-425	Fluid Service: Normal
Minimum Test Pressure (psig)	900	900	915	930	940	900	625	Material: Stainless Steel (316L)
Maximum Test Pressure (psig)	1780							Pressure Rating: 600 psi
								External Pressure Rating: 15 psi

GENERAL NOTES

Refer to General Notes 1-9, 16-18.

ALLOWABLE TUBE MATERIALS

Component	Size	Rating	Standard	Material	Material Grade	Additional Requirements
Tubing	1/16 - 2	Schedule Tables	ASTM A269	ASTM A269	TP 316L	
Tubing	1/16 - 2	Schedule Tables	ASTM A249	ASTM A249	TP 316L	

REQUIRED THICKNESS FOR TUBE IN GAS SERVICE:

P-Spec	Corrosion Allowance	Pipe Size	1/8	3/16	1/4	5/16	3/8	1/2	5/8	3/4	7/8	1	1 1/4	1 1/2	2
A	0.00	Thickness	0.028	0.028	0.028	0.035	0.035	0.041	0.052	0.062	0.073	0.083	0.104	0.125	0.167
		Bend Radius	1.5D	1.5D	1.5D	1.5D	1.5D	1.5D	1.5D	1.5D	1.5D	1.5D	1.5D	1.5D	1.5D
B	0.01	Thickness	0.028	0.028	0.028	0.035	0.035	0.049	0.052	0.062	0.073	0.083	0.104	0.125	0.167
		Bend Radius	1.5D	1.5D	1.5D	1.5D	1.5D	1.5D	1.5D	1.5D	1.5D	1.5D	1.5D	1.5D	1.5D

REQUIRED THICKNESS FOR TUBE IN ALL OTHER SERVICES:

P-Spec	Corrosion Allowance	Pipe Size	1/16	1/8	3/16	1/4	5/16	3/8	1/2	5/8	3/4	7/8	1	1 1/4	1 1/2	2
A	0.00	Thickness	0.010	0.028	0.028	0.028	0.035	0.035	0.035	0.049	0.049	0.049	0.065	0.095	0.095	0.109
		Bend Radius	1.5D	1.5D	1.5D	1.5D	1.5D	1.5D	1.5D	1.5D	1.5D	1.5D	1.5D	1.5D	1.5D	1.5D
B	0.01	Thickness	0.020	0.028	0.028	0.035	0.035	0.035	0.049	0.049	0.049	0.065	0.065	0.095	0.095	0.109
		Bend Radius	3D	1.5D	1.5D	1.5D	1.5D	1.5D	1.5D	1.5D	1.5D	1.5D	1.5D	1.5D	1.5D	1.5D

FITTINGS

Component	Size	Rating	Standard	Material	Material Grade	Additional Requirements
Tube Fittings	1/16 - 2	Manufacturer's	Manufacturer's	ASTM A182/A479	316L/304L	Swagelok/Cajon or Parker
Welded Fittings	1/16 - 2	Manufacturer's	Manufacturer's	ASTM A182/A479	316L/304L	Swagelok/Cajon or Parker

Piping Specification 207	Date: September 17, 2014	Revision: 0	Page 1 of 1
--------------------------	--------------------------	-------------	-------------

DESIGN PARAMETERS

P-Spec	PS-207(A, B)							
Design Pressure (psig)	2000	2000	1890	1675	1555	1425	930	
Design Temperature (°F)	100	300	400	600	800	900	1000	
Minimum Temperature (°F)	-425	-425	-425	-425	-425	-425	-425	
Minimum Test Pressure (psig)	3000	3000	3055	3110	3140	3025	2080	
Maximum Test Pressure (psig)	3330							

Calculation Reference:	00-00-CALC-M-0004-R0
Code of Reference:	B31.3 - 2002
Fluid Service:	Normal
Material:	Stainless Steel (316L)
Pressure Rating:	2000 psi
External Pressure Rating:	15 psi

GENERAL NOTES

Refer to General Notes 1-11, 16-18.

ALLOWABLE TUBE MATERIALS

Component	Size	Rating	Standard	Material	Material Grade	Additional Requirements
Tubing	1/16 - 2	Schedule Tables	ASTM A269	ASTM A269	TP 316L	
Tubing	1/16 - 2	Schedule Tables	ASTM A249	ASTM A249	TP 316L	

REQUIRED THICKNESS FOR TUBE

P-Spec	Corrosion Allowance	Pipe Size	1/16	1/8	3/16	1/4	5/16	3/8	1/2	5/8	3/4	7/8	1	1 1/4	1 1/2	2
A	0.00	Thickness	0.010	0.028	0.028	0.035	0.083	0.049	0.083	0.083	0.095	0.095	0.120	0.156	0.188	0.188
		Bend Radius	1.5D	1.5D	1.5D	1.5D	1.5D	1.5D	1.5D	1.5D	1.5D	3D	3D	3D	3D	5D
B	0.01	Thickness	0.020	0.035	0.049	0.065	0.065	0.065	0.083	0.095	0.095	0.095	0.120	0.156	0.188	0.188
		Bend Radius	5D	1.5D	1.5D	1.5D	1.5D	3D	3D	3D	3D	5D	3D	3D	3D	-

FITTINGS

Component	Size	Rating	Standard	Material	Material Grade	Additional Requirements
Tube Fittings	1/16 - 2	Manufacturer's	Manufacturer's	ASTM A182/A479	316L/304L	Swagelok/Cajon or Parker
Welded Fittings	1/16 - 2	Manufacturer's	Manufacturer's	ASTM A182/A479	316L/304L	Swagelok/Cajon or Parker

Section REF References
REF-3 ASME B31.3 Process Piping Guide

Rev. 0, 9/17/2014

Piping Specification 208	Date: September 17, 2014	Revision: 0	Page 1 of 1
--------------------------	--------------------------	-------------	-------------

DESIGN PARAMETERS

P-Spec	PS-208(A, B, C)						
Design Pressure (psig)	800	675	605	550	510	480	460
Design Temperature (°F)	100	200	300	400	500	600	700
Minimum Temperature (°F)	-425	-425	-425	-425	-425	-425	-425
Minimum Test Pressure (psig)	1200	1015	910	875	865	860	855
Maximum Test Pressure (psig)	1215						

Calculation Reference:	00-00-CALC-M-0004-R0
Code of Reference:	B31.3 - 2002
Fluid Service:	Normal
Material:	Stainless Steel (304L)
Pressure Rating:	Class 400
External Pressure Rating:	15 psi

GENERAL NOTES

Refer to General Notes 1-12, 16-18.

ALLOWABLE PIPE MATERIALS

Component	Size	Rating	Standard	Material	Material Grade	Additional Requirements
Piping	¼ - 12	Schedule Tables	ASME B36.19	ASTM A312	TP 304L	Welded
Piping	¼ - 12	Schedule Tables	ASME B36.19	ASTM A312	TP 304L	Seamless

REQUIRED SCHEDULES FOR NON-THREADED PIPE

P-Spec	Corrosion Allowance	Pipe Size	Pipe Size												
			¼	½	¾	1	1½	2	2½	3	4	6	8	10	12
A	0.00	Schedule	10S	10S	10S	10S	10S	10S	40S	40S	40S	80S	40S	40S	80S
B	0.03	Schedule	40S	10S	40S	10S	40S	40S	40S	40S	40S	80S	80S	80S	80S
C	0.05	Schedule	80S	40S	80S	40S	80S	80S	40S	80S	80S	80S	80S	80S	80S

REQUIRED SCHEDULES FOR THREADED PIPE

P-Spec	Corrosion Allowance	Pipe Size	Pipe Size									
			¼	½	¾	1	1½	2	2½	3	4	6
A	0.00	Schedule	40S	40S	40S	40S	40S	80S	80S	80S	80S	80S
B	0.03	Schedule	80S	80S	80S	80S	80S	80S	80S	80S	80S	80S
C	0.05	Schedule	-	-	-	-	-	80S	80S	80S	80S	80S

FITTINGS

Component	Size	Rating	Standard	Material	Material Grade	Additional Requirements
Threaded Fittings	¼ - 4	2000#	ASME B16.11	ASTM A182	F304/F304L	
Socket-Weld Fittings	¼ - 2	3000#	ASME B16.11	ASTM A182	F304L	
Buttweld Fittings	½ - 12	Schedule Tables	ASME B16.9	ASTM A403	WP304L	
Buttweld Fittings	½ - 12	Schedule Tables	ASME B16.28	ASTM A403	WP304L	

FLANGES

Component	Size	Rating	Standard	Material	Material Grade	Additional Requirements
Socket-Weld Flange	½ - 2	Class 600	ASME B16.5	ASTM A182	F304L	Use Class 600 for NPS greater than 3
Threaded Flanges	½ - 6	Class 400, 600	ASME B16.5	ASTM A182	F304L	Use Class 600 for NPS greater than 3
Weldneck Flange	½ - 12	Class 400, 600	ASME B16.5	ASTM A182	F304L	Use Class 600 for NPS greater than 3
Slip-on Flange	½ - 12	Class 400, 600	ASME B16.5	ASTM A182	F304L	Use Class 600 for NPS greater than 3
Blind Flange	½ - 12	Class 400, 600	ASME B16.5	ASTM A182	F304L	Use Class 600 for NPS greater than 3
Backup Flange	½ - 12	Class 400, 600	ASME B16.5	ASTM A105	N/A	Min Temperature - 20°F. Use Class 600 for NPS greater than 3. See note 8

MECHANICAL FASTENERS

Component	Size	Standard	Material	Material Grade	Additional Requirements
Fasteners	½ - 1 ¼	ASME B18.2.1	ASTM A193	B8 Cl. 2-HH	Min Temperature - 325°F, See Note 10
Nuts	½ - 1 ¼	ASME B18.2.2	ASTM A194	8F-HH	

Piping Specification 209	Date: September 17, 2014	Revision: 0	Page 1 of 1
--------------------------	--------------------------	-------------	-------------

DESIGN PARAMETERS

P-Spec	PS-209(A, B, C)							Calculation Reference:	00-00-CALC-M-0004-R0
Design Pressure (psig)	1200	1015	910	825	765	720	685	Code of Reference:	B31.3 - 2002
Design Temperature (°F)	100	200	300	400	500	600	700	Fluid Service:	Normal
Minimum Temperature (°F)	-425	-425	-425	-425	-425	-425	-425	Material:	Stainless Steel (304L)
Minimum Test Pressure (psig)	1800	1525	1365	1310	1295	1290	1270	Pressure Rating:	Class 600
Maximum Test Pressure (psig)	1845							External Pressure Rating:	15 psi

GENERAL NOTES

Refer to General Notes 1-12, 16.

ALLOWABLE PIPE MATERIALS

Component	Size	Rating	Standard	Material	Material Grade	Additional Requirements
Piping	¼ - 8	Schedule Tables	ASME B36.19	ASTM A312	TP 304L	Welded
Piping	¼ - 8	Schedule Tables	ASME B36.19	ASTM A312	TP 304L	Seamless

REQUIRED SCHEDULES FOR NON-THREADED PIPE

P-Spec	Corrosion Allowance	Pipe Size	¼	½	¾	1	1 ½	2	2 ½	3	4	6	8
A	0.00	Schedule	10S	10S	10S	10S	40S	40S	40S	80S	80S	80S	80S
B	0.03	Schedule	40S	40S	40S	40S	80S	80S	80S	80S	80S	-	80S
C	0.05	Schedule	80S	80S	80S	80S	80S	-	80S	80S	-	-	80S

REQUIRED SCHEDULES FOR THREADED PIPE

P-Spec	Corrosion Allowance	Pipe Size	¼	½	¾	1	1 ½	2	2 ½	3
A	0.00	Schedule	40S	40S	80S	80S	80S	80S	80S	80S
B	0.03	Schedule	80S	80S	80S	80S	-	-	-	-
C	0.05	Schedule	-	-	-	-	-	-	-	-

FITTINGS

Component	Size	Rating	Standard	Material	Material Grade	Additional Requirements
Threaded Fittings	¼ - 3	2000#	ASME B16.11	ASTM A182	F304/F304L	
Socket-Weld Fittings	¼ - 2	3000#	ASME B16.11	ASTM A182	F304L	
Buttweld Fittings	½ - 8	Schedule Tables	ASME B16.9	ASTM A403	WP304L	
Buttweld Fittings	½ - 8	Schedule Tables	ASME B16.28	ASTM A403	WP304L	

FLANGES

Component	Size	Rating	Standard	Material	Material Grade	Additional Requirements
Socket-Weld Flange	½ - 2	Class 600	ASME B16.5	ASTM A182	F304L	
Threaded Flanges	½ - 3	Class 600	ASME B16.5	ASTM A182	F304L	
Weldneck Flange	½ - 8	Class 600	ASME B16.5	ASTM A182	F304L	
Slip-on Flange	½ - 8	Class 600	ASME B16.5	ASTM A182	F304L	
Blind Flange	½ - 8	Class 600	ASME B16.5	ASTM A182	F304L	
Backup Flange	½ - 8	Class 600	ASME B16.5	ASTM A105	N/A	Min Temperature - 20°F. See note 8

MECHANICAL FASTENERS

Component	Size	Standard	Material	Material Grade	Additional Requirements
Fasteners	½ - 1 ½	ASME B18.2.1	ASTM A193	B8 Cl. 2-HH	Min Temperature - 325°F, See Note 10
Nuts	½ - 1 ½	ASME B18.2.2	ASTM A194	8F-HH	

Section REF References

Rev. 0, 9/17/2014

REF-3 ASME B31.3 Process Piping Guide

Piping Specification 210	Date: September 17, 2014	Revision: 0	Page 1 of 1
--------------------------	--------------------------	-------------	-------------

DESIGN PARAMETERS

P-Spec	PS-210(A, B)						
	Design Pressure (psig)	600	480	445	405	260	125
Design Temperature (°F)	300	500	800	900	1000	1150	1400
Minimum Temperature (°F)	-425	-425	-425	-425	-425	-425	-425
Minimum Test Pressure (psig)	900	815	860	855	835	785	340
Maximum Test Pressure (psig)	935						

Calculation Reference:	00-00-CALC-M-0004-R0
Code of Reference:	B31.3 - 2002
Fluid Service:	Normal
Material:	Stainless Steel (304L)
Pressure Rating:	600 psi
External Pressure Rating:	15 psi

GENERAL NOTES

Refer to General Notes 1-12, 16, 19.

ALLOWABLE PIPE MATERIALS

Component	Size	Rating	Standard	Material	Material Grade	Additional Requirements
Piping	¼ - 12	Schedule Tables	ASME B36.19	ASTM A312	TP 304L	Seamless

REQUIRED SCHEDULES FOR NON-THREADED PIPE

P-Spec	Corrosion Allowance	Pipe Size	Schedule												
			¼	½	¾	1	1½	2	2½	3	4	6	8	10	12
A	0.00	Schedule	10S	10S	10S	10S	10S	10S	10S	10S	10S	40S	40S	40S	40S
B	0.03	Schedule	10S	10S	10S	10S	10S	10S	10S	10S	40S	40S	40S	40S	40S

REQUIRED SCHEDULES FOR THREADED PIPE

P-Spec	Corrosion Allowance	Pipe Size	Schedule					
			¼	½	¾	1	1½	2
A	0.00	Schedule	40S	40S	40S	40S	40S	40S
B	0.03	Schedule	80S	80S	80S	80S	80S	80S

FITTINGS

Component	Size	Rating	Standard	Material	Material Grade	Additional Requirements
Threaded Fittings	¼ - 4	2000#	ASME B16.11	ASTM A182	F304/F304L	Only for fit up to threaded components
Socket-Weld Fittings	¼ - 2	3000#	ASME B16.11	ASTM A182	F304L	
Buttweld Fittings	½ - 12	Schedule Tables	ASME B16.9	ASTM A403	WP304L	
Buttweld Fittings	½ - 12	Schedule Tables	ASME B16.28	ASTM A403	WP304L	

FLANGES

Component	Size	Rating	Standard	Material	Material Grade	Additional Requirements
Socket-Weld Flange	½ - 2	See note 19	ASME B16.5	ASTM A182	See note 19	
Threaded Flange	½ - 6	See note 19	ASME B16.5	ASTM A182	See note 19	
Weldneck Flange	½ - 8	See note 19	ASME B16.5	ASTM A182	See note 19	
Slip-on Flange	½ - 8	See note 19	ASME B16.5	ASTM A182	See note 19	
Blind Flange	½ - 8	See note 19	ASME B16.5	ASTM A182	See note 19	
Backup Flange	½ - 8	See note 19	ASME B16.5	ASTM A105	N/A	See note 8

MECHANICAL FASTENERS

Component	Size	Standard	Material	Material Grade	Additional Requirements
Fasteners	B16.5	ASME B18.2.1	ASTM A193	B8 Cl. 2-HH	Limited to 1000°F, See note 10
Nuts	B16.5	ASME B18.2.2	ASTM A194	8F-HH	Limited to 1000°F

Section REF References

Rev. 0, 9/17/2014

REF-3 ASME B31.3 Process Piping Guide

Piping Specification 211	Date: September 17, 2014	Revision: 0	Page 1 of 1
--------------------------	--------------------------	-------------	-------------

DESIGN PARAMETERS

P-Spec	PS-211(A, B)							Calculation Reference:	00-00-CALC-M-0004-R0
	Design Pressure (psig)	600	480	445	405	260	125	35	Code of Reference:
Design Temperature (°F)	300	500	800	900	1000	1150	1400	Fluid Service:	Normal
Minimum Temperature (°F)	-425	-425	-425	-425	-425	-425	-425	Material:	Stainless Steel (316L)
Minimum Test Pressure (psig)	900	835	900	860	585	355	340	Pressure Rating:	600 psi
Maximum Test Pressure (psig)	935							External Pressure Rating:	15 psi

GENERAL NOTES

Refer to General Notes 1-12, 16, 19.

ALLOWABLE PIPE MATERIALS

Component	Size	Rating	Standard	Material	Material Grade	Additional Requirements
Piping	¼ - 12	Schedule Tables	ASME B36.19	ASTM A312	TP 316L	Seamless

REQUIRED SCHEDULES FOR NON-THREADED PIPE

P-Spec	Corrosion Allowance	Pipe Size	Schedule													
			¼	½	¾	1	1½	2	2½	3	4	6	8	10	12	
A	0.00	Schedule	10S	10S	10S	10S	10S	10S	10S	10S	10S	10S	40S	40S	40S	40S
B	0.03	Schedule	10S	10S	10S	10S	10S	10S	10S	10S	40S	40S	40S	40S	40S	40S

REQUIRED SCHEDULES FOR THREADED PIPE

P-Spec	Corrosion Allowance	Pipe Size	Schedule										
			¼	½	¾	1	1½	2	2½	3	4	6	
A	0.00	Schedule	40S	40S	40S	40S	40S	40S	40S	40S	40S	40S	40S
B	0.03	Schedule	80S	80S	80S	80S	80S	80S	80S	80S	80S	80S	80S

FITTINGS

Component	Size	Rating	Standard	Material	Material Grade	Additional Requirements
Threaded Fittings	¼ - 4	2000#	ASME B16.11	ASTM A182	F316/F316L	Only for fit up to threaded components
Socket-Weld Fittings	¼ - 2	3000#	ASME B16.11	ASTM A182	F316L	
Buttweld Fittings	½ - 12	Schedule Tables	ASME B16.9	ASTM A403	WP316L	
Buttweld Fittings	½ - 12	Schedule Tables	ASME B16.28	ASTM A403	WP316L	

FLANGES

Component	Size	Rating	Standard	Material	Material Grade	Additional Requirements
Socket-Weld Flange	½ - 2	See note 19	ASME B16.5	ASTM A182	See note 19	
Threaded Flanges	½ - 6	See note 19	ASME B16.5	ASTM A182	See note 19	
Weldneck Flange	½ - 12	See note 19	ASME B16.5	ASTM A182	See note 19	
Slip-on Flange	½ - 12	See note 19	ASME B16.5	ASTM A182	See note 19	
Blind Flange	½ - 12	See note 19	ASME B16.5	ASTM A182	See note 19	
Backup Flange	½ - 12	See note 19	ASME B16.5	ASTM A105	N/A	

MECHANICAL FASTENERS

Component	Size	Standard	Material	Material Grade	Additional Requirements
Fasteners	½ - ⅝	ASME B18.2.1	ASTM A193	B8 Cl. 2-HH	Limited to 1000°F, See General Note 10.
Nuts	½ - ⅝	ASME B18.2.2	ASTM A194	8F-HH	Limited to 1000°F

Section REF References

Rev. 0, 9/17/2014

REF-3 ASME B31.3 Process Piping Guide

Piping Specification 212	Date: September 17, 2014	Revision: 0	Page 1 of 1
--------------------------	--------------------------	-------------	-------------

DESIGN PARAMETERS

P-Spec	PS-212(A, B)							Calculation Reference:	00-00-CALC-M-0004-R0
Design Pressure (psig)	1225	1155	1080	1020	950	870	570	Code of Reference:	B31.3 - 2002
Design Temperature (°F)	300	400	500	600	800	900	1000	Fluid Service:	Normal
Minimum Temperature (°F)	-425	-425	-425	-425	-425	-425	-425	Material:	Stainless Steel (304L)
Minimum Test Pressure (psig)	1840	1835	1830	1825	1835	1835	1835	Pressure Rating:	1225 psi
Maximum Test Pressure (psig)	1870							External Pressure Rating:	15 psi

GENERAL NOTES

Refer to General Notes 1-12, 16.

ALLOWABLE PIPE MATERIALS

Component	Size	Rating	Standard	Material	Material Grade	Additional Requirements
Piping	¼ - 10	Schedule Tables	ASME B36.19	ASTM A312	TP 304L	Seamless

REQUIRED SCHEDULES FOR NON-THREADED PIPE

P-Spec	Corrosion Allowance	Pipe Size	¼	½	¾	1	1½	2	2½	3	4	6	8	10
A	0.00	Schedule	10S	10S	10S	10S	10S	40S	40S	40S	40S	80S	80S	80S
B	0.03	Schedule	40S	40S	40S	40S	40S	80S	40S	80S	80S	80S	80S	80S

REQUIRED SCHEDULES FOR THREADED PIPE

P-Spec	Corrosion Allowance	Pipe Size	¼	½	¾	1	1½	2	2½	3	4	6
A	0.00	Schedule	40S	40S	40S	80S	80S	80S	80S	80S	80S	80S
B	0.03	Schedule	80S	80S	80S	80S	80S	80S	80S	80S	80S	80S

FITTINGS

Component	Size	Rating	Standard	Material	Material Grade	Additional Requirements
Threaded Fittings	¼ - 4	2000#	ASME B16.11	ASTM A182	F304L	Only for fit up to threaded components
Buttweld Fittings	½ - 10	Schedule Tables	ASME B16.9	ASTM A403	WP304L	
Buttweld Fittings	½ - 10	Schedule Tables	ASME B16.28	ASTM A403	WP304L	

FLANGES

Component	Size	Rating	Standard	Material	Material Grade	Additional Requirements
Weldneck Flange	½ - 10	Class 900, 1500	ASME B16.5	ASTM A182	F304L	Limited to 800°F. Use 1500 for NPS < 3
Slip-on Flange	½ - 10	Class 900, 1500	ASME B16.5	ASTM A182	F304L	Limited to 800°F. Use 1500 for NPS < 3
Threaded Flange	½ - 10	Class 900, 1500	ASME B16.5	ASTM A182	F304L	Limited to 800°F. Use 1500 for NPS < 3
Backup Flange	½ - 4	See note 19	ASME B16.5	ASTM A105	F304L	Limited to 800°F. See note 8

MECHANICAL FASTENERS

Component	Size	Standard	Material	Material Grade	Additional Requirements
Fasteners	B16.5	ASME B18.2.1	ASTM A193	B8 Cl. 2-HH	Limited to 1000°F, See General Note 10.
Nuts	B16.5	ASME B18.2.2	ASTM A194	8F-HH	Limited to 1000°F

Piping Specification 213	Date: September 17, 2014	Revision: 0	Page 1 of 1
--------------------------	--------------------------	-------------	-------------

DESIGN PARAMETERS

P-Spec	PS-213(A, B)						
	Design Pressure (psig)	3000	2530	2270	2065	1910	1800
Design Temperature (°F)	100	200	300	400	500	600	700
Minimum Temperature (°F)	-425	-425	-425	-425	-425	-425	-425
Minimum Test Pressure (psig)	4500	3795	3405	3275	3235	3220	3180
Maximum Test Pressure (psig)	4530						

Calculation Reference:	00-00-CALC-M-0004-R0
Code of Reference:	B31.3 - 2002
Fluid Service:	Normal
Material:	Stainless Steel (304L)
Pressure Rating:	Class 1500
External Pressure Rating:	15 psi

GENERAL NOTES

Refer to General Notes 1-11, 14, 16.

ALLOWABLE PIPE MATERIALS

Component	Size	Rating	Standard	Material	Material Grade	Additional Requirements
Piping	¼ - 6	Schedule Tables	ASME B36.10	ASTM A312	TP 304L	Seamless

REQUIRED SCHEDULES FOR NON-THREADED PIPE

P-Spec	Corrosion Allowance	Pipe Size	Schedule									
			¼	½	¾	1	1½	2	2½	3	4	6
A	0.00	Schedule	40	40	40	80	160	160	160	160	160	160
B	0.03	Schedule	80	80	80	160	160	160	160	160	160	XXS

FITTINGS

Component	Size	Rating	Standard	Material	Material Grade	Additional Requirements
Socket-Weld Fittings	¼ - 2	6000#	ASME B16.11	ASTM A182	F304L	
Buttweld Fittings	¼ - 6	Schedule Tables	ASME B16.9	ASTM A403	WP304L	
Buttweld Fittings	¼ - 6	Schedule Tables	ASME B16.28	ASTM A403	WP304L	

FLANGES

Component	Size	Rating	Standard	Material	Material Grade	Additional Requirements
Socket-Weld Flange	½ - 2	Class 1500	ASME B16.5	ASTM A182	F304L	
Weldneck Flange	½ - 6	Class 1500	ASME B16.5	ASTM A182	F304L	
Slip-on Flange	½ - 6	Class 1500	ASME B16.5	ASTM A182	F304L	

MECHANICAL FASTENERS

Component	Size	Standard	Material	Material Grade	Additional Requirements
Fasteners	¾ - 1 ¾	ASME B18.2.1	ASTM A193	B8 Cl. 2-HH	Limited to 1000°F, See General Note 10.
Nuts	¾ - 1 ¾	ASME B18.2.2	ASTM A194	8F-HH	Limited to 1000°F

Section REF References

Rev. 0, 9/17/2014

REF-3 ASME B31.3 Process Piping Guide

Piping Specification 214	Date: September 17, 2014	Revision: 0	Page 1 of 1
--------------------------	--------------------------	-------------	-------------

DESIGN PARAMETERS

P-Spec	PS-214(A, B)						
Design Pressure (psig)	5000	4220	3780	3440	3180	3000	2860
Design Temperature (°F)	100	200	300	400	500	600	700
Minimum Temperature (°F)	-425	-425	-425	-425	-425	-425	-425
Minimum Test Pressure (psig)	7500	6330	5670	5455	5380	5370	5310
Maximum Test Pressure (psig)	7645						

Calculation Reference:	00-00-CALC-M-0004-R0
Code of Reference:	B31.3 - 2002
Fluid Service:	Normal
Material:	Stainless Steel (304L)
Pressure Rating:	Class 2500
External Pressure Rating:	15 psi

GENERAL NOTES

Refer to General Notes 1-11, 14, 16.

ALLOWABLE PIPE MATERIALS

Component	Size	Rating	Standard	Material	Material Grade	Additional Requirements
Piping	¼ - 6	Schedule Tables	ASME B36.10	ASTM A312	TP 304L	Seamless

REQUIRED SCHEDULES FOR NON-THREADED PIPE

P-Spec	Corrosion Allowance	Pipe Size	Schedule							
			¼	½	¾	1	1 ½	2	2 ½	3
A	0.00	Schedule	80	80	160	160	XXS	XXS	XXS	XXS
B	0.03	Schedule	-	160	160	XXS	XXS	-	XXS	XXS

FITTINGS

Component	Size	Rating	Standard	Material	Material Grade	Additional Requirements
Socket-Weld Fittings	¼ - 2	9000#	ASME B16.11	ASTM A182	F304L	
Buttweld Fittings	¼ - 3	Schedule Tables	ASME B16.9	ASTM A403	WP304L	
Buttweld Fittings	¼ - 3	Schedule Tables	ASME B16.28	ASTM A403	WP304L	

FLANGES

Component	Size	Rating	Standard	Material	Material Grade	Additional Requirements
Socket-Weld Flange	½ - 2	Class 2500	ASME B16.5	ASTM A182	F304L	
Weldneck Flange	½ - 3	Class 2500	ASME B16.5	ASTM A182	F304L	
Slip-on Flange	½ - 3	Class 2500	ASME B16.5	ASTM A182	F304L	

MECHANICAL FASTENERS

Component	Size	Standard	Material	Material Grade	Additional Requirements
Fasteners	¾ - 1 ¼	ASME B18.2.1	ASTM A193	B8 Cl. 2-HH	See note 10.
Nuts	¾ - 1 ¼	ASME B18.2.2	ASTM A194	8F-HH	

Section REF References

Rev. 0, 9/17/2014

REF-3 ASME B31.3 Process Piping Guide

Piping Specification 215	Date: September 17, 2014	Revision: 0	Page 1 of 1
--------------------------	--------------------------	-------------	-------------

DESIGN PARAMETERS

P-Spec	PS-215(A, B, C)	
Design Pressure (psig)	230	195
Design Temperature (°F)	100	200
Minimum Temperature (°F)	-425	-425
Minimum Test Pressure (psig)	345	295
Maximum Test Pressure (psig)	365	

Calculation Reference:	00-00-CALC-M-0004-R0
Code of Reference:	B31.3 - 2002
Fluid Service:	Normal
Material:	Stainless Steel (316L)
Pressure Rating:	230 psi
External Pressure Rating:	15 psi

GENERAL NOTES

Refer to General Notes 1-12, 16.

ALLOWABLE PIPE MATERIALS

Component	Size	Rating	Standard	Material	Material Grade	Additional Requirements
Piping	¼ - 10	Schedule Tables	ASME B36.19	ASTM A312	TP316L	Welded
Piping	¼ - 10	Schedule Tables	ASME B36.19	ASTM A312	TP316L	Seamless

REQUIRED SCHEDULES FOR NON-THREADED PIPE

P-Spec	Corrosion Allowance	Pipe Size	Pipe Size											
			¼	½	¾	1	1½	2	2½	3	4	6	8	10
A	0.00	Schedule	10S	10S	10S	10S	10S	10S	10S	10S	10S	10S	10S	10S
B	0.03	Schedule	10S	10S	10S	10S	10S	10S	10S	10S	10S	10S	10S	10S
C	0.05	Schedule	40S	10S	40S	10S	10S	10S	10S	10S	10S	10S	10S	10S

REQUIRED SCHEDULES FOR THREADED PIPE

P-Spec	Corrosion Allowance	Pipe Size	Pipe Size										
			¼	½	¾	1	1½	2	2½	3	4	6	
A	0.00	Schedule	40S	40S	40S	40S	40S	40S	40S	40S	40S	40S	40S
B	0.03	Schedule	80S	80S	40S	40S	40S	40S	40S	40S	40S	40S	40S
C	0.05	Schedule	80S	80S	80S	80S	80S	80S	40S	40S	40S	40S	40S

FITTINGS

Component	Size	Rating	Standard	Material	Material Grade	Additional Requirements
Socket-Weld Fittings	¼ - 2	3000#	ASME B16.11	ASTM A182	F316L	
Threaded Fittings	¼ - 4	2000#	ASME B16.11	ASRM A182	F316L	
Buttweld Fittings	½ - 10	Schedule Tables	ASME B16.9	ASTM A403	WP316L	
Buttweld Fittings	½ - 10	Schedule Tables	ASME B16.28	ASTM A403	WP316L	
Victaulic Zero-Flex Coupling 07	1 - 10	Manufacturer's	Manufacturer's	Manufacturer's	Manufacturer's	Use with EPDM gaskets, Min Temp -20°F.

FLANGES

Component	Size	Rating	Standard	Material	Material Grade	Additional Requirements
Socket-Weld Flange	½ - 2	Class 150	ASME B16.5	ASTM A182	F316L	
Threaded Flange	½ - 6	Class 150	ASME B16.5	ASTM A182	F316L	
Weldneck Flange	½ - 10	Class 150	ASME B16.5	ASTM A182	F316L	
Slip-on Flange	½ - 10	Class 150	ASME B16.5	ASTM A182	F316L	
Blind Flange	½ - 10	Class 150	ASME B16.5	ASTM A182	F316L	
Backup Flange	½ - 10	Class 150	ASME B16.5	ASTM A105	N/A	Min Temperature - 20°F. See note 8
Backup Flange	½ - 10	Class 150	ASME B16.42	ASTM A395	N/A	Min Temp. - 20°F, Max. Temp. 650°F. See note 8

MECHANICAL FASTENERS

Component	Size	Standard	Material	Material Grade	Additional Requirements
Fasteners		ASME B18.2.1	ASTM A193	B8 Cl. 2-HH	Min Temperature - 325°F, See Note 10. Not for use with Victaulic Fittings
Nuts		ASME B18.2.2	ASTM A194	8F-HH	Not for use with Victaulic Fittings

Section REF References

Rev. 0, 9/17/2014

REF-3 ASME B31.3 Process Piping Guide

Piping Specification 300	Date: September 17, 2014	Revision: 0	Page 1 of 1
--------------------------	--------------------------	-------------	-------------

DESIGN PARAMETERS

P-Spec	PS-300(A, B, C, D)						
Design Pressure (psig)	230	195	175	160	145	140	110
Design Temperature (°F)	100	200	300	400	500	600	700
Minimum Temperature (°F)	-325	-325	-325	-325	-325	-325	-325
Minimum Test Pressure (psig)	345	295	265	240	220	225	190
Maximum Test Pressure (psig)	520						

Calculation Reference:	00-00-CALC-M-0004-R0
Code of Reference:	B31.3, 2002
Fluid Service:	Normal
Material:	Hastelloy C276
Pressure Rating:	Class 150
External Pressure Rating:	15 psi

GENERAL NOTES

Refer to General Notes 1-12, 16.

ALLOWABLE PIPE MATERIALS

Component	Size	Rating	Standard	Material	Material Grade	Additional Requirements
Piping	¼ - 24	Schedule Tables	ASME B619	N10276	Class I or II	Welded
Piping	¼ - 24	Schedule Tables	ASME B622	N10276	N/A	Seamless

REQUIRED SCHEDULES FOR NON-THREADED PIPE

P-Spec	Corrosion Allowance	Pipe Size	Pipe Schedules																		
			¼	½	¾	1	1½	2	2½	3	4	6	8	10	12	14	16	18	20	24	
A	0.00	Schedule	10S	10S	10S	10S	10S	10S	10S	10S	10S	10S	10S	10S	10S	10S	10S	10S	10S	10S	10S
B	0.03	Schedule	10S	10S	10S	10S	10S	10S	10S	10S	10S	10S	10S	10S	10S	10S	10S	10S	10S	10S	10S
C	0.05	Schedule	40S	10S	10S	10S	10S	10S	10S	10S	10S	10S	10S	10S	10S	10S	10S	10S	10S	10S	10S
D	0.095	Schedule	-	80S	80S	80S	80S	80S	40S	40S	40S	40S	40S	40S	40S	-	-	-	-	-	-

REQUIRED SCHEDULES FOR THREADED PIPE

P-Spec	Corrosion Allowance	Pipe Size	Pipe Schedules									
			¼	½	¾	1	1½	2	2½	3	4	6
A	0.00	Schedule	40S	40S	40S	40S	40S	40S	40S	40S	40S	40S
B	0.03	Schedule	80S	40S	40S	40S	40S	40S	40S	40S	40S	40S
C	0.05	Schedule	80S	80S	80S	80S	80S	40S	40S	40S	40S	40S
D	0.095	Schedule	-	-	-	-	80S	80S	80S	80S	80S	40S

FITTINGS

Component	Size	Rating	Standard	Material	Material Grade	Additional Requirements
Threaded Fittings	¼ - 4	2000#	ASME B16.11	B574/B622	N10276	Engineering approval required.
Buttweld Fittings	½ - 24	Schedule Tables	ASME B16.9	B366	WPHC276	
Buttweld Fittings	½ - 24	Schedule Tables	ASME B16.28	B366	WPHC276	

FLANGES

Component	Size	Rating	Standard	Material	Material Grade	Additional Requirements
Threaded Flange	¼ - 4	Class 150	ASME B16.5	B574/B575	N10276	Engineering approval required
Weldneck Flange	½ - 24	Class 150	ASME B16.5	B574/B575	N10276	
Slip-on Flange	½ - 24	Class 150	ASME B16.5	B574/B575	N10276	Refer to note 5
Blind Flange	½ - 24	Class 150	ASME B16.5	B574/575	N10276	
Backup Flange	½ - 24	Class 150	ASME B16.5	A182/A744	F304/CF-8	

MECHANICAL FASTENERS

Component	Size	Standard	Material	Material Grade	Additional Requirements
Fasteners	½ - 1 ¼	ASME B18.2.1	ASTM A193	B8 Cl. 2-HH	Refer to General Note 10.
Nuts	½ - 1 ¼	ASME B18.2.2	ASTM A194	8F-HH	

Section REF References

Rev. 0, 9/17/2014

REF-3 ASME B31.3 Process Piping Guide

Piping Specification 301	Date: September 17, 2014	Revision: 0	Page 1 of 1
--------------------------	--------------------------	-------------	-------------

DESIGN PARAMETERS

P-Spec	PS-301(A, B, C, D)							Calculation Reference:	00-00-CALC-M-0004-R0
Design Pressure (psig)	720	600	530	470	435	415	405	Code of Reference:	B31.3, 2002
Design Temperature (°F)	100	200	300	400	500	600	700	Fluid Service:	Normal
Minimum Temperature (°F)	-325	-325	-325	-325	-325	-325	-325	Material:	Hastelloy C276
Minimum Test Pressure (psig)	1080	900	795	705	660	670	690	Pressure Rating:	Class 300
Maximum Test Pressure (psig)	1225							External Pressure Rating:	15 psi

GENERAL NOTES

Refer to General Notes 1-12, 16.

ALLOWABLE PIPE MATERIALS

Component	Size	Rating	Standard	Material	Material Grade	Additional Requirements
Piping	¼ - 12	Schedule Tables	ASME B619	N10276	Class I or II	Welded
Piping	¼ - 12	Schedule Tables	ASME B622	N10276	N/A	Seamless

REQUIRED SCHEDULES FOR NON-THREADED PIPE

P-Spec	Corrosion Allowance	Pipe Size	¼	½	¾	1	1 ½	2	2 ½	3	4	6	8	10	12
A	0.00	Schedule	10S	10S	10S	10S	10S	10S	10S	10S	10S	40S	40S	40S	40S
B	0.03	Schedule	10S	10S	10S	10S	10S	10S	10S	40S	40S	40S	40S	40S	40S
C	0.05	Schedule	40S	40S	40S	10S	40S	40S	40S	40S	40S	40S	40S	40S	40S
D	0.095	Schedule	-	-	-	80S	80S	80S	80S	80S	80S	80S	40S	40S	40S

REQUIRED SCHEDULES FOR THREADED PIPE

P-Spec	Corrosion Allowance	Pipe Size	¼	½	¾	1	1 ½	2	2 ½	3	4	6
A	0.00	Schedule	40S	40S	40S	40S	40S	40S	40S	40S	40S	40S
B	0.03	Schedule	80S	80S	80S	80S	80S	80S	40S	40S	40S	40S
C	0.05	Schedule	80S	80S	80S	80S	80S	80S	80S	80S	80S	80S
D	0.095	Schedule	-	-	-	-	-	-	-	80S	80S	80S

FITTINGS

Component	Size	Rating	Standard	Material	Material Grade	Additional Requirements
Threaded Fittings	¼ - 4	2000#	ASME B16.11	B574/B622	N10276	Engineering approval required.
Buttweld Fittings	½ - 12	Schedule Tables	ASME B16.9	B366	WPHC276	
Buttweld Fittings	½ - 12	Schedule Tables	ASME B16.28	B366	WPHC276	

FLANGES

Component	Size	Rating	Standard	Material	Material Grade	Additional Requirements
Threaded Flange	¼ - 4	Class 150	ASME B16.5	B574/B575	N10276	Engineering approval required
Weldneck Flange	½ - 12	Class 150	ASME B16.5	B574/B575	N10276	
Slip-on Flange	½ - 12	Class 150	ASME B16.5	B574/B575	N10276	
Blind Flange	½ - 12	Class 150	ASME B16.5	B574/575	N10276	
Backup Flange	½ - 12	Class 150	ASME B16.5	A182/A744	F304/CF-8	

MECHANICAL FASTENERS

Component	Size	Standard	Material	Material Grade	Additional Requirements
Fasteners	½ - 1 ½	ASME B18.2.1	ASTM A193	B8 Cl. 2-HH	Refer to General Note 10.
Nuts	½ - 1 ½	ASME B18.2.2	ASTM A194	8F-HH	

Section REF References

Rev. 0, 9/17/2014

REF-3 ASME B31.3 Process Piping Guide

Piping Specification 302	Date: September 17, 2014	Revision: 0	Page 1 of 1
--------------------------	--------------------------	-------------	-------------

DESIGN PARAMETERS

P-Spec	PS-302(A, B, C, D)							Calculation Reference:	00-00-CALC-M-0004-R0
Design Pressure (psig)	230	215	200	185	170	140	110	Code of Reference:	B31.3, 2002
Design Temperature (°F)	100	200	300	400	500	600	700	Fluid Service:	Normal
Minimum Temperature (°F)	-325	-325	-325	-325	-325	-325	-325	Material:	Alloy 20 (N08020)
Minimum Test Pressure (psig)	360	340	325	300	270	230	180	Pressure Rating:	Class 150
Maximum Test Pressure (psig)	445							External Pressure Rating:	15 psi

GENERAL NOTES

Refer to General Notes 1-12, 16.

ALLOWABLE PIPE MATERIALS

Component	Size	Rating	Standard	Material	Material Grade	Additional Requirements
Piping	¼ - 24	Schedule Tables	ASTM B464	N08020	N/A	Welded
Piping	¼ - 24	Schedule Tables	ASTM B729	N08020	N/A	Manuf. Hydrostatic Test

REQUIRED SCHEDULES FOR NON-THREADED PIPE

P-Spec	Corrosion Allowance	Pipe Size	¼	½	¾	1	1 ½	2	2 ½	3	4	6	8	10	12	14	16	18	20	24
A	0.00	Schedule	10S	10S	10S	10S	10S	10S	10S	10S	10S	10S	10S	10S	10S	10S	10S	10S	10S	10S
B	0.03	Schedule	10S	10S	10S	10S	10S	10S	10S	10S	10S	10S	10S	10S	10S	10S	10S	10S	10S	10S
C	0.05	Schedule	40S	10S	40S	10S	10S	10S	10S	10S	10S	40S	10S	10S	10S	10S	10S	-	-	-
D	0.07	Schedule	80S	80S	40S	40S	40S	40S	40S	40S	40S	40S	40S	40S	40S	40S	-	-	-	-

REQUIRED SCHEDULES FOR THREADED PIPE

P-Spec	Corrosion Allowance	Pipe Size	¼	½	¾	1	1 ½	2	2 ½	3	4	6
A	0.00	Schedule	40S	40S	40S	40S	40S	40S	40S	40S	40S	40S
B	0.03	Schedule	80S	40S	40S	40S	40S	40S	40S	40S	40S	40S
C	0.05	Schedule	80S	80S	80S	80S	80S	80S	40S	40S	40S	40S
D	0.07	Schedule	-	-	80S	80S	80S	80S	80S	80S	40S	40S

FITTINGS

Component	Size	Rating	Standard	Material	Material Grade	Additional Requirements
Threaded Fittings	¼ - 4	2000#	ASME B16.11	B462	N08020	Engineering approval required.
Buttweld Fittings	½ - 24	Schedule Tables	ASME B16.9	B366	WP20CB	
Buttweld Fittings	½ - 24	Schedule Tables	ASME B16.28	B366	WP20CB	

FLANGES

Component	Size	Rating	Standard	Material	Material Grade	Additional Requirements
Threaded Flange	¼ - 4	Class 150	ASME B16.5	B462	N08020	Engineering approval required
Weldneck Flange	½ - 24	Class 150	ASME B16.5	B462	N08020	
Slip-on Flange	½ - 24	Class 150	ASME B16.5	B462	N08020	
Blind Flange	½ - 24	Class 150	ASME B16.5	B462	N08020	
Backup Flange	½ - 24	Class 150	ASME B16.5	A105/A182	N/A/F304	

MECHANICAL FASTENERS

Component	Size	Standard	Material	Material Grade	Additional Requirements
Fasteners	½ - 1 ½	ASME B18.2.1	ASTM A193	B8 Cl. 2-HH	Refer to General Note 10.
Nuts	½ - 1 ½	ASME B18.2.2	ASTM A194	8F-HH	

Piping Specification 303	Date: September 17, 2014	Revision: 0	Page 1 of 1
--------------------------	--------------------------	-------------	-------------

DESIGN PARAMETERS

P-Spec	PS-303(A, B, C, D)							Calculation Reference:	00-00-CALC-M-0004-R0
Design Pressure (psig)	600	555	525	480	470	455	445	Code of Reference:	B31.3, 2002
Design Temperature (°F)	100	200	300	400	500	600	700	Fluid Service:	Normal
Minimum Temperature (°F)	-325	-325	-325	-325	-325	-325	-325	Material:	Alloy 20 (N08020)
Minimum Test Pressure (psig)	945	885	850	785	770	745	730	Pressure Rating:	Class 300
Maximum Test Pressure (psig)	1075							External Pressure Rating:	15 psi

GENERAL NOTES

Refer to General Notes 1-12, 16.

ALLOWABLE PIPE MATERIALS

Component	Size	Rating	Standard	Material	Material Grade	Additional Requirements
Piping	¼ - 12	Schedule Tables	ASTM B464	N08020	N/A	Welded
Piping	¼ - 12	Schedule Tables	ASTM B729	N08020	N/A	Manufacturer Hydrostatic Test

REQUIRED SCHEDULES FOR NON-THREADED PIPE

P-Spec	Corrosion Allowance	Pipe Size	Pipe Schedules														
			¼	½	¾	1	1 ½	2	2 ½	3	4	6	8	10	12		
A	0.00	Schedule	10S	10S	10S	10S	10S	10S	10S	10S	10S	40S	40S	40S	40S	40S	40S
B	0.03	Schedule	10S	10S	10S	10S	10S	10S	10S	40S	40S	40S	40S	40S	40S	40S	40S
C	0.05	Schedule	40S	40S	40S	40S	40S	40S	40S	40S	40S	40S	40S	40S	40S	40S	40S
D	0.07	Schedule	80S	80S	80S	80S	80S	80S	80S	40S	40S	40S	40S	40S	40S	40S	40S

REQUIRED SCHEDULES FOR THREADED PIPE

P-Spec	Corrosion Allowance	Pipe Size	Pipe Schedules										
			¼	½	¾	1	1 ½	2	2 ½	3	4	6	
A	0.00	Schedule	40S	40S	40S	40S	40S	40S	40S	40S	40S	40S	40S
B	0.03	Schedule	80S	80S	80S	80S	80S	80S	80S	80S	80S	80S	80S
C	0.05	Schedule	-	80S	80S	80S	80S	80S	80S	80S	80S	80S	80S
D	0.07	Schedule	-	-	-	-	80S	80S	80S	80S	80S	80S	80S

FITTINGS

Component	Size	Rating	Standard	Material	Material Grade	Additional Requirements
Threaded Fittings	¼ - 4	2000#	ASME B16.11	B462	N08020	Engineering approval required.
Buttweld Fittings	½ - 12	Schedule Tables	ASME B16.9	B366	WP20CB	
Buttweld Fittings	½ - 12	Schedule Tables	ASME B16.28	B366	WP20CB	

FLANGES

Component	Size	Rating	Standard	Material	Material Grade	Additional Requirements
Threaded Flange	¼ - 4	Class 300	ASME B16.5	B462	N08020	Engineering approval required
Weldneck Flange	½ - 12	Class 300	ASME B16.5	B462	N08020	
Slip-on Flange	½ - 12	Class 300	ASME B16.5	B462	N08020	
Blind Flange	½ - 12	Class 300	ASME B16.5	B462	N08020	
Backup Flange	½ - 12	Class 300	ASME B16.5	A105/A182	N/A/F304	

MECHANICAL FASTENERS

Component	Size	Standard	Material	Material Grade	Additional Requirements
Fasteners	½ - 1 ½	ASME B18.2.1	ASTM A193	B8 Cl. 2-HH	Refer to General Note 10.
Nuts	½ - 1 ½	ASME B18.2.2	ASTM A194	8F-HH	

Section REF References

Rev. 0, 9/17/2014

REF-3 ASME B31.3 Process Piping Guide

Piping Specification 304	Date: September 17, 2014	Revision: 0	Page 1 of 1
--------------------------	--------------------------	-------------	-------------

DESIGN PARAMETERS

P-Spec	PS-304(A, B, C, D)							Calculation Reference:	00-00-CALC-M-0004-R0
Design Pressure (psig)	275	260	80	50	35	25	25	Code of Reference:	B31.3, 2002
Design Temperature (°F)	100	200	800	900	1000	1150	1200	Fluid Service:	Normal
Minimum Temperature (°F)	-325	-325	-325	-325	-325	-325	-325	Material:	Inconel 600 (N06600)
Minimum Test Pressure (psig)	415	390	120	95	150	245	245	Pressure Rating:	Class 150
Maximum Test Pressure (psig)	445							External Pressure Rating:	15 psi

GENERAL NOTES

Refer to General Notes 1-12, 16.

ALLOWABLE PIPE MATERIALS

Component	Size	Rating	Standard	Material	Material Grade	Additional Requirements
Piping	¼ - 6	Schedule Tables	ASTM B167	N06600	N/A	Seamless, Mnfr Hydro. Test ASTM B517
Piping	¼ - 24	Schedule Tables	ASTM B517	N06600	N/A	Mnfr Hydro. Test ASTM B517

REQUIRED SCHEDULES FOR NON-THREADED PIPE

P-Spec	Corrosion Allowance	Pipe Size	¼	½	¾	1	1 ½	2	2 ½	3	4	6	8	10	12	14	16	18	20	24
A	0.00	Schedule	10S	10S	10S	10S	10S	10S	10S	10S	10S	40S	10S	10S	10S	10S	10S	10S	10S	10S
B	0.03	Schedule	10S	10S	10S	10S	10S	10S	10S	10S	10S	40S	10S	10S	10S	10S	10S	-	10S	-
C	0.05	Schedule	40S	10S	40S	10S	10S	10S	10S	10S	10S	40S	10S	10S	10S	10S	-	-	-	-
D	0.07	Schedule	80S	80S	80S	40S	40S	40S	40S	40S	40S	40S	40S	40S	40S	-	-	-	-	-

REQUIRED SCHEDULES FOR THREADED PIPE

P-Spec	Corrosion Allowance	Pipe Size	¼	½	¾	1	1 ½	2	2 ½	3	4	6
A	0.00	Schedule	40S	40S	40S	40S	40S	40S	40S	40S	40S	40S
B	0.03	Schedule	80S	40S	40S	40S	40S	40S	40S	40S	40S	40S
C	0.05	Schedule	80S	80S	80S	80S	80S	80S	40S	40S	40S	40S
D	0.07	Schedule	-	-	-	80S	80S	80S	80S	80S	40S	40S

FITTINGS

Component	Size	Rating	Standard	Material	Material Grade	Additional Requirements
Threaded Fittings	¼ - 4	2000#	ASME B16.11	B564	N06600	Engineering approval required
Buttweld Fittings	½ - 24	Schedule Tables	ASME B16.9	B366	WPNCI	Seamless or welded
Buttweld Fittings	½ - 24	Schedule Tables	ASME B16.28	B366	WPNCI	Seamless or welded

FLANGES

Component	Size	Rating	Standard	Material	Material Grade	Additional Requirements
Weldneck Flange	½ - 24	Class 150	ASME B16.5	B564/B168	N06600	Only up to 90°
Blind Flange	½ - 24	Class 150	ASME B16.5	B564/B168	N06600	Only up to 90°
Backup Flange	½ - 24	Class 150	ASME B16.5	A105	N/A	Only up to 90°

MECHANICAL FASTENERS

Component	Size	Standard	Material	Material Grade	Additional Requirements
Fasteners	½ - 1 ½	ASME B18.2.1	ASTM A193	B8 C1. 2-HH	Refer to General Note 10.
Nuts	½ - 1 ½	ASME B18.2.2	ASTM A194	8F-HH	

Piping Specification 305	Date: September 17, 2014	Revision: 0	Page 1 of 1
--------------------------	--------------------------	-------------	-------------

DESIGN PARAMETERS

P-Spec	PS-305(A, B, C, D)							Calculation Reference:	00-00-CALC-M-0004-R0
Design Pressure (psig)	290	260	200	140	110	80	65	Code of Reference:	B31.3, 2002
Design Temperature (°F)	100	200	400	600	700	800	850	Fluid Service:	Normal
Minimum Temperature (°F)	-325	-325	-325	-325	-325	-325	-325	Material:	Inconel 690 (N06690)
Minimum Test Pressure (psig)	435	430	365	265	210	150	125	Pressure Rating:	Class 150
Maximum Test Pressure (psig)	600							External Pressure Rating:	15 psi

GENERAL NOTES

Refer to General Notes 1-12, 16.

ALLOWABLE PIPE MATERIALS

Component	Size	Rating	Standard	Material	Material Grade	Additional Requirements
Piping	¼ - 12	Schedule Tables	ASTM B167	N06690	N/A	Seamless

REQUIRED SCHEDULES FOR NON-THREADED PIPE

P-Spec	Corrosion Allowance	Pipe Size	¼	½	¾	1	1 ½	2	2 ½	3	4	6	8	10	12
A	0.00	Schedule	10S	10S	10S	10S	10S	10S	10S	10S	10S	10S	10S	40S	40S
B	0.03	Schedule	10S	10S	10S	10S	10S	10S	10S	10S	40S	40S	40S	40S	40S
C	0.05	Schedule	40S	40S	40S	10S	40S	40S	40S	40S	40S	40S	40S	40S	40S
D	0.07	Schedule	80S	80S	80S	40S	40S	40S	40S	40S	40S	40S	40S	40S	40S

REQUIRED SCHEDULES FOR THREADED PIPE

P-Spec	Corrosion Allowance	Pipe Size	¼	½	¾	1	1 ½	2	2 ½	3	4	6
A	0.00	Schedule	40S	40S	40S	40S	40S	40S	40S	40S	40S	40S
B	0.03	Schedule	80S	80S	80S	80S	40S	40S	40S	40S	40S	40S
C	0.05	Schedule	80S	80S	80S	80S	80S	80S	80S	80S	80S	40S
D	0.07	Schedule	-	-	-	-	80S	80S	80S	80S	80S	80S

FITTINGS

Component	Size	Rating	Standard	Material	Material Grade	Additional Requirements
Buttweld Fittings	½ - 6	Schedule Tables	ASME B16.9	B366	WP***S	Seamless, Alloy N06690 required
Buttweld Fittings	½ - 6	Schedule Tables	ASME B16.28	B366	WP***S	Seamless, Alloy N06690 required.

FLANGES

Component	Size	Rating	Standard	Material	Material Grade	Additional Requirements
Weldneck Flange	½ - 6	Class 150	ASME B16.5	B564/B168	N06690	
Blind Flange	½ - 6	Class 150	ASME B16.5	B564/B168	N06690	
Backup Flange	½ - 6	Class 150	ASME B16.5	A105	N/A	

MECHANICAL FASTENERS

Component	Size	Standard	Material	Material Grade	Additional Requirements
Fasteners	½ - ¾	ASME B18.2.1	ASTM A193	B8	Refer to General Note 10.
Nuts	½ - ¾	ASME B18.2.2	ASTM A194	8F-HH	

Piping Specification 306	Date: September 17, 2014	Revision: 0	Page 1 of 1
--------------------------	--------------------------	-------------	-------------

DESIGN PARAMETERS

P-Spec	PS-306(A, B, C)							Calculation Reference:	00-00-CALC-M-0004-R0
Design Pressure (psig)	230	200	190	185	170	140	125	Code of Reference:	B31.3, 2002
Design Temperature (°F)	100	200	300	400	500	600	650	Fluid Service:	Normal
Minimum Temperature (°F)	-325	-325	-325	-325	-325	-325	-325	Material:	Monel (N04400)
Minimum Test Pressure (psig)	360	335	330	320	295	245	225	Pressure Rating:	Class 150
Maximum Test Pressure (psig)	395							External Pressure Rating:	15 psi

GENERAL NOTES

Refer to General Notes 1-12, 16.

ALLOWABLE PIPE MATERIALS

Component	Size	Rating	Standard	Material	Material Grade	Additional Requirements
Piping	¼ - 8	Schedule Tables	ASTM B165	N04400	N/A	Seamless

REQUIRED SCHEDULES FOR NON-THREADED PIPE

P-Spec	Corrosion Allowance	Pipe Size	¼	½	¾	1	1 ½	2	2 ½	3	4	6	8
A	0.00	Schedule	10S	10S	10S	10S	10S	10S	10S	10S	10S	40S	10S
B	0.03	Schedule	10S	10S	10S	10S	10S	10S	10S	10S	10S	10S	10S
C	0.05	Schedule	40S	10S	40S	10S	10S	10S	10S	10S	40S	40S	10S

REQUIRED SCHEDULES FOR THREADED PIPE

P-Spec	Corrosion Allowance	Pipe Size	¼	½	¾	1	1 ½	2	2 ½	3	4	6
A	0.00	Schedule	40S	40S	40S	40S	40S	40S	40S	40S	40S	40S
B	0.03	Schedule	80S	40S	40S	40S	40S	40S	40S	40S	40S	40S
C	0.05	Schedule	80S	80S	80S	80S	80S	80S	40S	40S	40S	40S

FITTINGS

Component	Size	Rating	Standard	Material	Material Grade	Additional Requirements
Threaded Fittings	¼ - 6	2000#	ASME B16.11	B564	N04400	Engineering approval required
Buttweld Fittings	½ - 8	Schedule Tables	ASME B16.9	B366	WPNC	Seamless or welded
Buttweld Fittings	½ - 8	Schedule Tables	ASME B16.28	B366	WPNC	

FLANGES

Component	Size	Rating	Standard	Material	Material Grade	Additional Requirements
Weldneck Flange	½ - 8	Class 150	ASME B16.5	B564/B127	N04400	
Blind Flange	½ - 8	Class 150	ASME B16.5	B564/B127	N04400	
Backup Flange	½ - 8	Class 150	ASME B16.5	A105	N/A	

MECHANICAL FASTENERS

Component	Size	Standard	Material	Material Grade	Additional Requirements
Fasteners	½ - ¾	ASME B18.2.1	ASTM A193	B8 C1.2-HH	Refer to General Note 10.
Nuts	½ - ¾	ASME B18.2.2	ASTM A194	8F-HH	

Section REF References

Rev. 0, 9/17/2014

REF-3 ASME B31.3 Process Piping Guide

Piping Specification 400	Date: September 17, 2014	Revision: 0	Page 1 of 1
--------------------------	--------------------------	-------------	-------------

DESIGN PARAMETERS

P-Spec	PS-400
Design Pressure (psig)	150
Design Temperature (°F)	250
Minimum Temperature (°F)	-20
Minimum Test Pressure (psig)	280
Maximum Test Pressure (psig)	295

Calculation Reference:	00-00-CALC-M-0004-R0
Code of Reference:	B31.3, 2002
Fluid Service:	Category D
Material:	Copper
Pressure Rating:	150 psi
External Pressure Rating:	15 psi

GENERAL NOTES

Refer to General Notes 1, 3, 5-10, 20-24.

ALLOWABLE TUBE MATERIALS

Component	Size	Rating	Standard	Material	Material Grade	Additional Requirements
Tubing	¼ - 4	Type L	ASTM B88	ASTM B88	Temper 050,060,H	Seamless
Tubing	¼ - 4	Type K	ASTM B88	ASTM B88	Temper 050,060,H	Seamless

REQUIRED SCHEDULES FOR TUBE

P-Spec	Corrosion Allowance	Pipe Size	¼	⅜	½	⅝	¾	1	1 ¼	1 ½	2	2 ½	3	3 ½	4
400	0.00	Thickness	0.030	0.035	0.040	0.042	0.045	0.050	0.055	0.060	0.070	0.080	0.090	0.100	0.110
		Bend Radius	3D	3D	3D	3D	3D	3D	3D	3D	3D	3D	3D	3D	3D

FITTINGS

Component	Size	Rating	Standard	Material	Material Grade	Additional Requirements
Threaded Fittings	¼ - 4	Class 125	ASME B16.15	AST B62	N/A	Max Temperature 350°
Soldered Fittings	¼ - 4	Type L	ASME B16.18	ASTM B62	N/A	
Soldered Fittings	¼ - 4	Type L	ASME B16.22	ASME B16.22	N/A	
Flared Fittings	⅝ - 2	175 psig	ASME B16.26	ASTM B62	N/A	Max Temperature 100°
Flared Fittings	¼ - 2	500 psig	SAE J513	SAE J513	N/A	With Flare Nuts, Max Temp 200 °
Tube Fittings	¼ - 2	Manufacturer's	Manufacturer's	Brass per Manufacturer's	N/A	Swagelok/Cajon/ or Parker

FLANGES

Component	Size	Rating	Standard	Material	Material Grade	Additional Requirements
Threaded Flange	½ - 4	Class 150	ASME B16.24	ASTM B61	N/A	
Threaded Flanges	½ - 4	Class 150	ASME B16.24	ASTM B62	N/A	

MECHANICAL FASTENERS

Component	Size	Rating	Standard	Material	Material Grade	Additional Requirements
Fasteners	½ - ⅝	N/A	ASME B18.2.1	ASTM A193	B8 Cl. 1-HH	Refer to General Note 10.
Nuts	½ - ⅝	N/A	ASME B18.2.2	ASTM A194	8F-HH	

Piping Specification 401	Date: September 17, 2014	Revision: 0	Page 1 of 1
--------------------------	--------------------------	-------------	-------------

DESIGN PARAMETERS

P-Spec	PS-401						
Design Pressure (psig)	225	225	210	195	180	165	130
Design Temperature (°F)	100	150	200	250	300	350	400
Minimum Temperature (°F)	-452	-452	-452	-452	-452	-452	-452
Minimum Test Pressure (psig)	340	400	395	365	345	370	390
Maximum Test Pressure (psig)	410						

Calculation Reference:	00-00-CALC-M-0004-R0
Code of Reference:	B31.3, 2002
Fluid Service:	Normal
Material:	Copper
Pressure Rating:	225 psi
External Pressure Rating:	N/A

GENERAL NOTES

Refer to General Notes 1, 3, 5-10, 21, 22, 24-26.

ALLOWABLE TUBE MATERIALS

Component	Size	Rating	Standard	Material	Material Grade	Additional Requirements
Tubing	¼ - 4	Type L	ASTM B88	ASTM B88	Temper 050,060, H	Seamless
Tubing	¼ - 4	Type K	ASTM B88	ASTM B88	Temper 050,060, H	Seamless

REQUIRED SCHEDULES FOR TUBE

P-Spec	Corrosion Allowance	Pipe Size	¼	⅜	½	⅝	¾	1	1 ¼	1 ½	2	2 ½	3	3 ½	4
401	0.00	Thickness	0.030	0.035	0.040	0.042	0.045	0.050	0.055	0.060	0.070	0.080	0.090	0.100	0.110
		Bend Radius	3D	3D	3D	3D	3D	3D	3D	3D	3D	3D	5D	5D	-

FITTINGS

Component	Size	Rating	Standard	Material	Material Grade	Additional Requirements
Threaded Fittings	¼ - 4	Class 125	ASME B16.15	AST B62	N/A	Max Temperature 350°
Soldered Fittings	¼ - 4	Type L	ASME B16.18	ASTM B62	N/A	
Soldered Fittings	¼ - 4	Type L	ASME B16.22	ASME B16.22	N/A	
Flared Fittings	¼ - 2	500 psig	SAE J513	SAE J513	N/A	With Flare Nuts, Max Temp 200 °
Tube Fittings	¼ - 2	Manufacturer's	Manufacturer's	Brass per Manufacturer's	N/A	Swagelok/Cajon/ or Parker

FLANGES

Component	Size	Rating	Standard	Material	Material Grade	Additional Requirements
Threaded Flange	½ - 4	Class 150	ASME B16.24	ASTM B61	N/A	
Threaded Flanges	½ - 4	Class 150	ASME B16.24	ASTM B62	N/A	

MECHANICAL FASTENERS

Component	Size	Rating	Standard	Material	Material Grade	Additional Requirements
Fasteners	½ - ⅝	N/A	ASME B18.2.1	ASTM A193	B8 Cl. 1-HH	Refer to General Note 10.
Nuts	½ - ⅝	N/A	ASME B18.2.2	ASTM A194	8F-HH	

Piping Specification 402	Date: September 17, 2014	Revision: 0	Page 1 of 1
--------------------------	--------------------------	-------------	-------------

DESIGN PARAMETERS

P-Spec	PS-402						
Design Pressure (psig)	355	300	280	280	275	235	175
Design Temperature (°F)	100	150	200	250	300	350	400
Minimum Temperature (°F)	-452	-452	-452	-452	-452	-452	-452
Minimum Test Pressure (psig)	535	530	525	525	525	530	525
Maximum Test Pressure (psig)	560						

Calculation Reference:	00-00-CALC-M-0004-R0
Code of Reference:	B31.3, 2002
Fluid Service:	Normal
Material:	Copper
Pressure Rating:	355 psi
External Pressure Rating:	N/A

GENERAL NOTES

Refer to General Notes 1, 3, 5-10, 21, 22, 24-26.

ALLOWABLE TUBE MATERIALS

Component	Size	Rating	Standard	Material	Material Grade	Additional Requirements
Tubing	¼ - 2	Type L	ASTM B88	ASTM B88	Temper 050,060, H	Seamless
Tubing	¼ - 2	Type K	ASTM B88	ASTM B88	Temper 050,060, H	Seamless

REQUIRED SCHEDULES FOR TUBE

P-Spec	Corrosion Allowance	Pipe Size	¼	⅜	½	⅝	¾	1	1 ¼	1 ½	2
402	0.00	Thickness	0.030	0.035	0.040	0.042	0.045	0.050	0.055	0.060	0.070
		Bend Radius	3D	3D	3D	3D	3D	3D	5D	5D	-

FITTINGS

Component	Size	Rating	Standard	Material	Material Grade	Additional Requirements
Threaded Fittings	¼ - 2	Class 250	ASME B16.15	AST B62	N/A	Max Temperature 350°
Soldered Fittings	¼ - 2	Type L	ASME B16.18	ASTM B62	N/A	Brazed
Soldered Fittings	¼ - 2	Type L	ASME B16.22	ASME B16.22	N/A	Brazed
Flared Fittings	¼ - 2	500 psig	SAE J513	SAE J513	N/A	With Flare Nuts, Max Temp 200 °
Tube Fittings	¼ - 2	Manufacturer's	Manufacturer's	Brass per Manufacturer's	N/A	Swagelok/Cajon/ or Parker

FLANGES

Component	Size	Rating	Standard	Material	Material Grade	Additional Requirements
Threaded Flange	½ - 2	Class 300	ASME B16.24	ASTM B61	N/A	
Threaded Flanges	½ - 2	Class 300	ASME B16.24	ASTM B62	N/A	

MECHANICAL FASTENERS

Component	Size	Rating	Standard	Material	Material Grade	Additional Requirements
Fasteners	½ - ¾	N/A	ASME B18.2.1	ASTM A193	B8 Cl. 1- HH	Min temperature - 325°F, See note 10
Nuts	½ - ¾	N/A	ASME B18.2.2	ASTM A194	8F- HH	

Piping Specification 403	Date: September 17, 2014	Revision: 0	Page 1 of 1
--------------------------	--------------------------	-------------	-------------

DESIGN PARAMETERS

P-Spec	PS-403						
Design Pressure (psig)	320	270	255	255	250	210	160
Design Temperature (°F)	100	150	200	250	300	350	400
Minimum Temperature (°F)	-452	-452	-452	-452	-452	-452	-452
Minimum Test Pressure (psig)	480	475	480	480	480	475	480
Maximum Test Pressure (psig)	495						

Calculation Reference:	00-00-CALC-M-0004-R0
Code of Reference:	B31.3, 2002
Fluid Service:	Normal
Material:	Copper
Pressure Rating:	400 psi
External Pressure Rating:	N/A

GENERAL NOTES

Refer to General Notes 1, 3, 5-10, 21, 22, 24-27.

ALLOWABLE TUBE MATERIALS

Component	Size	Rating	Standard	Material	Material Grade	Additional Requirements
Tubing	¼ - ¾	Type L	ASTM B88	ASTM B88	Temper 050,060, H	Seamless, Clean per ASTM B280
Tubing	¼ - 2	Type K	ASTM B88	ASTM B88	Temper 050,060, H	Seamless, Clean per ASTM B280

REQUIRED SCHEDULES FOR TUBE

P-Spec	Corrosion Allowance	Pipe Size	¼	⅜	½	⅝	¾	1	1 ¼	1 ½	2
403	0.00	Thickness	0.030	0.035	0.040	0.042	0.065	0.065	0.065	0.072	0.083
		Bend Radius	3D	3D	3D	3D	1.5D	3D	3D	3D	5D

FITTINGS

Component	Size	Rating	Standard	Material	Material Grade	Additional Requirements
Threaded Fittings	¼ - 2	Class 250	ASME B16.15	AST B62	N/A	Max Temperature 350°
Soldered Fittings	¼ - 2	Type L	ASME B16.18	ASTM B62	N/A	Brazed
Soldered Fittings	⅝ - 2	Type L	ASME B16.22	ASME B16.22	N/A	Brazed
Flared Fittings	⅝ - 2	500 psig	SAE J513	SAE J513	N/A	With Flare Nuts, Max Temp 200°
Tube Fittings	¼ - 2	Manufacturer's	Manufacturer's	Brass per Manufacturer's	N/A	Swagelok/Cajon/ or Parker

FLANGES

Component	Size	Rating	Standard	Material	Material Grade	Additional Requirements
Threaded Flange	½ - 2	Class 300	ASME B16.24	ASTM B61	N/A	
Threaded Flanges	½ - 2	Class 300	ASME B16.24	ASTM B62	N/A	

MECHANICAL FASTENERS

Component	Size	Rating	Standard	Material	Material Grade	Additional Requirements
Fasteners	½ - ¾	N/A	ASME B18.2.1	ASTM A193	B8 Cl. 1- HH	Min temperature - 325°F, See note 10
Nuts	½ - ¾	N/A	ASME B18.2.2	ASTM A194	8F- HH	

Section REF References
REF-3 ASME B31.3 Process Piping Guide

Rev. 0, 9/17/2014

Piping Specification 404	Date: September 17, 2014	Revision: 0	Page 1 of 1
--------------------------	--------------------------	-------------	-------------

DESIGN PARAMETERS

P-Spec	PS-404			
Design Pressure (psig)	275	270	265	260
Design Temperature (°F)	100	150	200	250
Minimum Temperature (°F)	-452	-452	-452	-452
Minimum Test Pressure (psig)	415	405	400	390
Maximum Test Pressure (psig)	445			

Calculation Reference:	00-00-CALC-M-0004-R0
Code of Reference:	B31.3, 2002
Fluid Service:	Normal
Material:	Aluminum (6061/6063)
Pressure Rating:	Class 150
External Pressure Rating:	N/A

GENERAL NOTES

Refer to General Notes 1-12.

ALLOWABLE PIPE MATERIALS

Component	Size	Rating	Standard	Material	Material Grade	Additional Requirements
Piping	¼ - 12	Schedule Tables	ASTM B241	ASTM B241	6061-T6	Seamless
Piping	¼ - 12	Schedule Tables	ASTM B241	ASTM B241	6063-T6	Seamless

REQUIRED SCHEDULES FOR NON-THREADED PIPE

P-Spec	Corrosion Allowance	Pipe Size	¼	½	¾	1	1 ½	2	2 ½	3	4	6	8	10	12
404	0.00	Thickness	10	10	10	10	10	10	10	10	40	40	40	40	40

REQUIRED SCHEDULES FOR THREADED PIPE

P-Spec	Corrosion Allowance	Pipe Size	¼	½	¾	1	1 ½	2	2 ½	3	4	6
404	0.00	Thickness	40	40	40	40	40	40	80	40	40	40

FITTINGS

Component	Size	Rating	Standard	Material	Material Grade	Additional Requirements
Socket Weld Fittings	¼ - 2	3000#	ASTM B361	ASTM B361	WP6061	Ref. ASME B16.11 for dimensions
Buttweld Fittings	½ - 12	Schedule Tables	ASTM B361	ASTM B361	WP6061	Ref. ASME B16.9 for dimensions
Buttweld Fittings	½ - 12	Schedule Tables	ASTM B361	ASTM B361	WP6061	Ref. ASME B16.28 for dimensions

FLANGES

Component	Size	Rating	Standard	Material	Material Grade	Additional Requirements
Threaded Flange	½ - 1 5/8	Class 150	B31.3 App. L	ASTM B247	6061-T6	ASME B16.5 for dimensions
Threaded Flanges	½ - 1 5/8	Class 150	B31.3 App. L	ASTM B247	6061-T6	ASME B16.5 for dimensions

MECHANICAL FASTENERS

Component	Size	Rating	Standard	Material	Material Grade	Additional Requirements
Fasteners	½ - 7/8	N/A	ASME B18.2.1	ASTM A193	B8 Cl. 1- HH	Min temperature - 325°F, See note 10
Fasteners	½ - 7/8	N/A	ASME B18.2.1	ASTM B211	6061 - T6 - HH	See note 10
Nuts	½ - 7/8	N/A	ASME B18.2.2	ASTM A194	8F- HH	Use with B8 Cl. 1
Nuts	½ - 7/8	N/A	ASME B18.2.2	ASTM B211	6061 - T6 - HH	Use with 6061 - T6 Fastener

Section REF References

Rev. 0, 9/17/2014

REF-3 ASME B31.3 Process Piping Guide

Piping Specification 405	Date: September 17, 2014	Revision: 0	Page 1 of 1
--------------------------	--------------------------	-------------	-------------

DESIGN PARAMETERS

P-Spec	PS-405			
Design Pressure (psig)	275	270	265	260
Design Temperature (°F)	100	150	200	250
Minimum Temperature (°F)	-452	-452	-452	-452
Minimum Test Pressure (psig)	415	405	400	390
Maximum Test Pressure (psig)	455			

Calculation Reference:	00-00-CALC-M-0004-R0
Code of Reference:	B31.3, 2002
Fluid Service:	Normal
Material:	Aluminum (6061/6063)
Pressure Rating:	275 psi
External Pressure Rating:	N/A

GENERAL NOTES

Refer to General Notes 1-9, 28.

ALLOWABLE TUBE MATERIALS

Component	Size	Rating	Standard	Material	Material Grade	Additional Requirements
Tubing	½ - 2	Schedule Tables	ASTM B241	ASTM B241	6061-T6	Seamless
Tubing	½ - 2	Schedule Tables	ASTM B241	ASTM B241	6063-T6	Seamless

REQUIRED SCHEDULES FOR TUBE

P-Spec	Corrosion Allowance	Pipe Size	⅛	⅜	¼	⅝	⅜	½	⅝	¾	7/8	1	1¼	1½	2
405	0.00	Thickness	0.035	0.035	0.035	0.035	0.035	0.035	0.049	0.049	0.049	0.065	0.065	0.083	0.095
		Bend Radius	1.5D	1.5D	1.5D	1.5D	1.5D	1.5D	1.5D	1.5D	1.5D	1.5D	1.5D	1.5D	1.5D

FITTINGS

Component	Size	Rating	Standard	Material	Material Grade	Additional Requirements
Tube	½ - 2	Manufacturer's	Manufacturer's	ASTM B211	6061 - T6	
Buttweld Fittings	¼ - 1	Manufacturer's	Manufacturer's	ASTM B211	2014T	

Section REF References

Rev. 0, 9/17/2014

REF-3 ASME B31.3 Process Piping Guide

Piping Specification 500	Date: September 17, 2014	Revision: 0	Page 1 of 1
--------------------------	--------------------------	-------------	-------------

DESIGN PARAMETERS

P-Spec	PS-500
Design Pressure (psig)	150
Design Temperature (°F)	100
Minimum Temperature (°F)	0
Minimum Test Pressure (psig)	225
Maximum Test Pressure (psig)	590

Calculation Reference:	00-00-CALC-M-0004-R0
Code of Reference:	B31.3, 2002
Fluid Service:	Normal
Material:	PVC
Pressure Rating:	150 psi
External Pressure Rating:	N/A

GENERAL NOTES

Refer to General Notes 1-3, 5-7, 9, 10, 13, 28 -30.

ALLOWABLE PIPE MATERIALS

Component	Size	Rating	Standard	Material	Material Grade	Additional Requirements
Piping	¼ - 8	Schedule Tables	ASTM D1784	ASTM D1784	12454-B	Note 30
Piping	¼ - 8	Schedule Tables	ASTM D1784	ASTM D1784	12454-C	Note 30

REQUIRED SCHEDULES FOR PIPE

P-Spec	Corrosion Allowance	Pipe Size	¼	½	¾	1	1 ½	2	2 ½	3	4	6	8
500	0.00	Schedule	40	40	40	40	40	40	40	40	40	80	80

FITTINGS

Component	Size	Rating	Standard	Material	Material Grade	Additional Requirements
Threaded Fittings	¼ - 4	40	ASTM D2466	ASTM D1784	12454-B, 12454-C	
Threaded Fittings	½ - 4	80	ASTM D2464	ASTM D1784	12454-B, 12454-C	
Solvent Welded Fittings	½ - 8	80	ASTM D2467	ASTM D1784	12454-B, 12454-C	

FLANGES

Component	Size	Rating	Standard	Material	Material Grade	Additional Requirements
Threaded Flange	¼ - 8	Class 150	ASME B16.5	ASTM A105	N/A	
Threaded Flange	½ - 8	Class 150	ASME B16.5	ASTM A182	304L/316L	
Solvent Welded Flange	½ - 8	Sch. 80	Manufacturer's	ASTM D1784	12454-B, 12454-C	

MECHANICAL FASTENERS

Component	Size	Rating	Standard	Material	Material Grade	Additional Requirements
Fasteners	½ - ¾	N/A	ASME B18.2.1	ASTM A307	Grade A	See Note 10.
Nuts	½ - ¾	N/A	ASME B18.2.2	ASTM A563	Grade B	

Piping Specification 501	Date: September 17, 2014	Revision: 0	Page 1 of 1
--------------------------	--------------------------	-------------	-------------

DESIGN PARAMETERS

P-Spec	PS-501	
Design Pressure (psig)	150	40
Design Temperature (°F)	100	180
Minimum Temperature (°F)	0	0
Minimum Test Pressure (psig)	280	240
Maximum Test Pressure (psig)	310	

Calculation Reference:	00-00-CALC-M-0004-R0
Code of Reference:	B31.3, 2002
Fluid Service:	Normal
Material:	CPVC
Pressure Rating:	150 psi
External Pressure Rating:	N/A

GENERAL NOTES

Refer to General Notes 1-3, 5-7, 9, 10, 13, 29 - 31.
--

ALLOWABLE PIPE MATERIALS

Component	Size	Rating	Standard	Material	Material Grade	Additional Requirements
Piping	¼ - 8	Schedule Tables	ASTM F441	ASTM D1784	23447-B (CPVC 4120)	Note 30
Piping	¼ - 8	Schedule Tables	ASTM F442	ASTM D1784	23447-B (CPVC 4120)	Note 30, 31.

REQUIRED SCHEDULES FOR NON-THREADED PIPE

P-Spec	Corrosion Allowance	Pipe Size	¼	½	¾	1	1 ½	2	2 ½	3	4	6	8
501	0.00	Schedule	40	40	40	40	40	40	40	40	40	80	80

REQUIRED SCHEDULES FOR THREADED PIPE

P-Spec	Corrosion Allowance	Pipe Size	¼	½	¾	1	1 ½	2	2 ½	3	4
501	0.00	Schedule	80	80	80	80	80	-	80	80	80

FITTINGS

Component	Size	Rating	Standard	Material	Material Grade	Additional Requirements
Threaded Fittings	¼ - 4	80	ASTM F437	ASTM D1784	23447-B (CPVC 4120)	
Solvent Welded Fittings	¼ - 4	40	ASTM F438	ASTM D1784	23447-B (CPVC 4120)	
Solvent Welded Fittings	¼ - 8	80	ASTM F439	ASTM D1784	23447-B (CPVC 4120)	

FLANGES

Component	Size	Rating	Standard	Material	Material Grade	Additional Requirements
Threaded Flange	½ - 8	Class 150	ASME B16.5	ASTM A105	N/A	
Threaded Flange	½ - 8	Class 150	ASME B16.5	ASTM A182	304L/316L	
Solvent Welded Flange	½ - 8	Sch. 80	Manufacturer's	ASTM D1784	23447-B (CPVC 4120)	

MECHANICAL FASTENERS

Component	Size	Rating	Standard	Material	Material Grade	Additional Requirements
Fasteners	½ - ¾	N/A	ASME B18.2.1	ASTM A307	Grade A	See Note 10
Nuts	½ - ¾	N/A	ASME B18.2.2	ASTM A563	Grade B	

Piping Specification 502	Date: September 17, 2014	Revision: 0	Page 1 of 1
--------------------------	--------------------------	-------------	-------------

DESIGN PARAMETERS

P-Spec	PS-502 (A, B, C, D, E, F, G)						
Design Pressure (psig)	200	193	160	128	110	100	80
Design Temperature (°F)	73	73	73	73	73	73	73
Minimum Temperature (°F)	0	0	0	0	0	0	0
Minimum Test Pressure (psig)	300	290	240	190	165	150	120
Maximum Test Pressure (psig)	330						

Calculation Reference:	00-00-CALC-M-0004-R0
Code of Reference:	B31.3, 2002
Fluid Service:	Normal
Material:	Polyethylene (PE)
Pressure Rating:	200 psi

GENERAL NOTES

Refer to General Notes 1-3, 5, 7, 9-11, 13, 29, 30, 32, 33.

ALLOWABLE PIPE MATERIALS

Component	Size	Rating	Standard	Material	Material Grade	Additional Requirements
Piping	½ - 12	Design Parameters	ASTM D3035	ASTM D3035	PE3408	Note 30
Piping	½ - 12	Design Parameters	ASTM D2513	ASTM D3035	PE3408	Note 30
Tubing	¼ - 1 ¾	Design Parameters	ASTM D2513	ASTM D3035	PE3408	Note 30
Tubing	½ - 2	Design Parameters	ASTM D2737	ASTM D3035	PE3408	Note 30

REQUIRED DR SCHEDULES FOR PIPE

P-Spec	Corrosion Allowance	Design Pressure at 73°	Pipe Size	½	¾	1	1 ¼	1½	2	3	4	6	8	10	12	14
A	0.00	200	DR	9	9	9	9	9	9	9	9	9	9	9	9	9
B	0.00	193	DR	9.3	9.3	9.3	9.3	9.3	9.3	9.3	9.3	9.3	9.3	9.3	9.3	9.3
C	0.00	160	DR	11	11	11	11	11	11	11	11	11	11	11	11	11
D	0.00	128	DR	13.5	13.5	13.5	13.5	13.5	13.5	13.5	13.5	13.5	13.5	13.5	13.5	13.5
E	0.00	110	DR	15.5	15.5	15.5	15.5	15.5	15.5	15.5	15.5	15.5	15.5	15.5	15.5	15.5
F	0.00	100	DR	17	17	17	17	17	17	17	17	17	17	17	17	17
G	0.00	80	DR	21	21	21	21	21	21	21	21	21	21	21	21	21

REQUIRED DR SCHEDULES FOR TUBE

P-Spec	Corrosion Allowance	Design Pressure at 73°	Pipe Size	¼	⅜	½	⅝	¾	1	1 ¼	1 ½	1 ¾	2
A	0.00	200	DR	9	9	9	9	9	9	9	9	9	9
B	0.00	193	DR	9.3	9.3	9.3	9.3	9.3	9.3	9.3	9.3	9.3	9.3
C	0.00	160	DR	11	11	11	11	11	11	11	11	11	11
D	0.00	128	DR	13.5	13.5	13.5	13.5	13.5	13.5	13.5	13.5	13.5	13.5
E	0.00	110	DR	15.5	15.5	15.5	15.5	15.5	15.5	15.5	15.5	15.5	15.5
F	0.00	100	DR	17	17	17	17	17	17	17	17	17	17
G	0.00	80	DR	21	21	21	21	21	21	21	21	21	21

FITTINGS

Component	Size	Rating	Standard	Material	Material Grade	Additional Requirements
Butt Fusion Fittings	¼ - 12	Note	ASTM D3261	ASTM D1248	P34 (PE3408)	
Solvent Welded Fittings (Pipe)	¼ - 4	Note	ASTM D2683	ASTM D1248	P34 (PE3408)	Type III, Class B or C
Solvent Welded Fittings (Pipe)	¼ - 1¼	Note	ASTM D2683	ASTM D1248	P34 (PE3408)	Type III, Class B or C

FLANGES

Component	Size	Rating	Standard	Material	Material Grade	Additional Requirements
Backup Flange Flange	½ - 12	Class 150	ASME B16.5	ASTM A105	N/A	

MECHANICAL FASTENERS

Component	Size	Rating	Standard	Material	Material Grade	Additional Requirements
Fasteners	½ - ⅞	N/A	ASME B18.2.1	ASTM A307	Grade A	See Note 10.
Nuts	½ - ⅞	N/A	ASME B18.2.2	ASTM A563	Grade B	

Section REF References

Rev. 0, 9/17/2014

REF-3 ASME B31.3 Process Piping Guide

Piping Specification 900	Date: September 17, 2014	Revision: 0	Page 1 of 1
--------------------------	--------------------------	-------------	-------------

DESIGN PARAMETERS

P-Spec	PS-900(A, B, C, D)						
Design Pressure (psig)	285	230	170	140	110	95	80
Design Temperature (°F)	100	300	500	600	700	750	800
Minimum Temperature (°F)	-20	-20	-20	-20	-20	-20	-20
Minimum Test Pressure (psig)	430	345	270	245	200	220	220
Maximum Test Pressure (psig)	820						

Calculation Reference:	00-00-CALC-M-0004-R0
Code of Reference:	B31.1, 2001
Fluid Service:	Non-BEP
Material:	Carbon Steel
Pressure Rating:	Class 150
External Pressure Rating:	15 psi

GENERAL NOTES

Refer to General Notes 3, 4, 6, 8-12, 34-39.
--

ALLOWABLE PIPE MATERIALS

Component	Size	Rating	Standard	Material	Material Grade	Additional Requirements
Piping	¼ - 24	Schedule Tables	ASME B36.10	ASTM A53	B	See General Note 38.
Piping	¼ - 24	Schedule Tables	ASME B36.10	ASTM A106	B	

REQUIRED SCHEDULES FOR NON-THREADED PIPE

P-Spec	Corrosion Allowance	Pipe Size	Pipe Schedules																		
			¼	½	¾	1	1½	2	2½	3	4	6	8	10	12	14	16	18	20	24	
A	0.00	Schedule	STD	STD	STD	STD	STD	STD	STD	STD	STD	STD	STD	STD	STD	STD	STD	STD	STD	STD	STD
B	0.03	Schedule	STD	STD	STD	STD	STD	STD	STD	STD	STD	STD	STD	STD	STD	STD	STD	STD	STD	STD	STD
C	0.05	Schedule	STD	STD	STD	STD	STD	STD	STD	STD	STD	STD	STD	STD	STD	STD	STD	STD	STD	STD	STD
D	0.07	Schedule	80	80	80	STD	STD	STD	STD	STD	STD	STD	STD	STD	STD	STD	STD	STD	STD	STD	STD

REQUIRED SCHEDULES FOR THREADED PIPE

P-Spec	Corrosion Allowance	Pipe Size	Pipe Schedules									
			¼	½	¾	1	1½	2	2½	3	4	6
A	0.000	Schedule	80	80	80	80	80	STD	STD	STD	STD	STD
B	0.030	Schedule	80	80	80	80	80	STD	STD	STD	STD	STD
C	0.060	Schedule	80	80	80	80	80	STD	STD	STD	STD	STD
D	0.070	Schedule	-	160	160	80	80	80	80	80	80	STD

FITTINGS

Component	Size	Rating	Standard	Material	Material Grade	Additional Requirements
Threaded Fittings	¼ - 4	2000#	ASME B16.11	ASTM A105	WP	Only where threaded pipe is ≤ sch. 80
Socket-Weld Fittings	¼ - 2	3000#	ASME B16.11	ASTM A105	WP	
Buttweld Fittings	¼ - 24	Schedule Tables	ASME B16.9	ASTM A234	WPB	
Buttweld Fittings	¼ - 24	Schedule Tables	ASME B16.28	ASTM A234	WPB	

FLANGES

Component	Size	Rating	Standard	Material	Material Grade	Additional Requirements
Threaded Flange	½ - 6	Class 150	ASME B16.5	ASTM A105	N/A	
Socket-Weld Flange	½ - 2	Class 150	ASME B16.5	ASTM A105	N/A	
Weldneck Flange	½ - 24	Class 150	ASME B16.5	ASTM A105	N/A	
Slip-on Flange	½ - 24	Class 150	ASME B16.5	ASTM A105	N/A	
Backup Flange	½ - 24	Class 150	ASME B16.5	ASTM A105	N/A	

MECHANICAL FASTENERS

Component	Size	Standard	Material	Material Grade	Additional Requirements
Fasteners	½ - 1 ¼	ASME B18.2.1	ASTM A193	B7-HH	Limited to 600°F, See Note 10.
Nuts	½ - 1 ¼	ASME B18.2.2	ASTM A194	2H-HH	

Section REF References

Rev. 0, 9/17/2014

REF-3 ASME B31.3 Process Piping Guide

Piping Specification 901	Date: September 17, 2014	Revision: 0	Page 1 of 1
--------------------------	--------------------------	-------------	-------------

DESIGN PARAMETERS

P-Spec	PS-901(A, B, C, D)						
Design Pressure (psig)	740	655	600	550	535	535	505
Design Temperature (°F)	100	300	500	600	650	700	750
Minimum Temperature (°F)	-20	-20	-20	-20	-20	-20	-20
Minimum Test Pressure (psig)	1110	985	950	955	945	975	1165
Maximum Test Pressure (psig)	1325						

Calculation Reference:	00-00-CALC-M-0004-R0
Code of Reference:	B31.1, 2001
Fluid Service:	Non-BEP
Material:	Carbon Steel
Pressure Rating:	Class 300
External Pressure Rating:	15 psi

GENERAL NOTES

Refer to General Notes 3, 4, 6, 8-12, 34-39.
--

ALLOWABLE PIPE MATERIALS

Component	Size	Rating	Standard	Material	Material Grade	Additional Requirements
Piping	¼ - 24	Schedule Tables	ASME B36.10	ASTM A53	B	See General Note 38.
Piping	¼ - 24	Schedule Tables	ASME B36.10	ASTM A106	B	

REQUIRED SCHEDULES FOR NON-THREADED PIPE

P-Spec	Corrosion Allowance	Pipe Size	Pipe Schedules																			
			¼	½	¾	1	1½	2	2½	3	4	6	8	10	12	14	16	18	20	24		
A	0.00	Schedule	STD	STD	STD	STD	STD	STD	STD	STD	STD	STD	STD	STD	STD	STD	STD	40	XS	40	40	
B	0.03	Schedule	STD	STD	STD	STD	STD	STD	STD	STD	STD	STD	STD	STD	STD	STD	STD	40	40	XS	40	40
C	0.05	Schedule	80	STD	STD	STD	STD	STD	STD	STD	STD	STD	STD	STD	STD	STD	STD	40	40	40	40	40
D	0.07	Schedule	80	80	80	80	80	80	80	STD	STD	80	80	STD	STD	XS	XS	40	40	40	40	

REQUIRED SCHEDULES FOR THREADED PIPE

P-Spec	Corrosion Allowance	Pipe Size	Pipe Schedules									
			¼	½	¾	1	1½	2	2½	3	4	6
A	0.000	Schedule	80	80	80	80	80	STD	STD	STD	STD	STD
B	0.030	Schedule	80	80	80	80	80	80	80	80	80	80
C	0.060	Schedule	-	80	80	80	80	80	80	80	80	80
D	0.070	Schedule	-	160	160	160	160	160	80	80	80	80

FITTINGS

Component	Size	Rating	Standard	Material	Material Grade	Additional Requirements
Threaded Fittings	¼ - 4	2000#/3000#	ASME B16.11	ASTM A105	WPB	2000# only where threaded pipe is ≤ sch. 80
Socket-Weld Fittings	¼ - 2	3000#	ASME B16.11	ASTM A105	WPB	
Buttweld Fittings	¼ - 24	Schedule Tables	ASME B16.9	ASTM A234	WPB	
Buttweld Fittings	¼ - 24	Schedule Tables	ASME B16.28	ASTM A234	WPB	

FLANGES

Component	Size	Rating	Standard	Material	Material Grade	Additional Requirements
Threaded Flange	½ - 6	Class 150	ASME B16.5	ASTM A105	N/A	
Socket-Weld Flange	½ - 2	Class 150	ASME B16.5	ASTM A105	N/A	
Weldneck Flange	½ - 24	Class 150	ASME B16.5	ASTM A105	N/A	
Slip-on Flange	½ - 24	Class 150	ASME B16.5	ASTM A105	N/A	
Backup Flange	½ - 24	Class 150	ASME B16.5	ASTM A105	N/A	

MECHANICAL FASTENERS

Component	Size	Standard	Material	Material Grade	Additional Requirements
Fasteners	½ - 1½	ASME B18.2.1	ASTM A193	B7-HH	Limited to 600°F, See Note 10.
Nuts	½ - 1½	ASME B18.2.2	ASTM A194	2H-HH	

Section REF References

Rev. 0, 9/17/2014

REF-3 ASME B31.3 Process Piping Guide

Piping Specification 902	Date: September 17, 2014	Revision: 0	Page 1 of 1
--------------------------	--------------------------	-------------	-------------

DESIGN PARAMETERS

P-Spec	PS-902(A, B, C, D)						
Design Pressure (psig)	1480	1315	1200	1095	1075	1065	1010
Design Temperature (°F)	100	300	500	600	650	700	750
Minimum Temperature (°F)	-20	-20	-20	-20	-20	-20	-20
Minimum Test Pressure (psig)	2220	1975	1905	1900	1900	1935	2330
Maximum Test Pressure (psig)	2740						

Calculation Reference:	00-00-CALC-M-0004-R0
Code of Reference:	B31.1, 2001
Fluid Service:	Non-BEP
Material:	Carbon Steel
Pressure Rating:	Class 600
External Pressure Rating:	15 psi

GENERAL NOTES

Refer to General Notes 3, 4, 6, 8-12, 34-39.
--

ALLOWABLE PIPE MATERIALS

Component	Size	Rating	Standard	Material	Material Grade	Additional Requirements
Piping	¼ - 24	Schedule Tables	ASME B36.10	ASTM A53	B	See General Note 38
Piping	¼ - 24	Schedule Tables	ASME B36.10	ASTM A106	B	

REQUIRED SCHEDULES FOR NON-THREADED PIPE

P-Spec	Corrosion Allowance	Pipe Size	Pipe Schedules																		
			¼	½	¾	1	1½	2	2½	3	4	6	8	10	12	14	16	18	20	24	
A	0.00	Schedule	STD	STD	STD	STD	STD	STD	STD	80	80	80	80	80	80	80	80	80	80	80	80
B	0.03	Schedule	STD	STD	STD	STD	80	80	80	80	80	120	80	80	80	80	80	100	100	100	100
C	0.05	Schedule	80	80	160	80	80	160	80	80	120	120	80	100	100	100	100	100	100	100	100
D	0.07	Schedule	-	160	160	160	160	160	160	160	120	120	100	100	100	100	100	100	100	100	100

REQUIRED SCHEDULES FOR THREADED PIPE

P-Spec	Corrosion Allowance	Pipe Size	Pipe Schedules									
			¼	½	¾	1	1½	2	2½	3	4	6
A	0.000	Schedule	80	80	80	80	80	80	80	80	120	120
B	0.030	Schedule	80	80	80	160	160	160	160	160	120	120
C	0.060	Schedule	-	160	160	160	160	160	160	160	120	120
D	0.070	Schedule	-	XXS	160	160	160	160	160	160	120	120

FITTINGS

Component	Size	Rating	Standard	Material	Material Grade	Additional Requirements
Threaded Fittings	¼ - 4	3000#	ASME B16.11	ASTM A105	WPB	Only where threaded pipe is ≤ sch. 160
Socket-Weld Fittings	¼ - 2	3000#/6000#	ASME B16.11	ASTM A105	WPB	3000# only where pipe is ≤ sch. 80
Buttweld Fittings	¼ - 24	Schedule Tables	ASME B16.9	ASTM A234	WPB	
Buttweld Fittings	¼ - 24	Schedule Tables	ASME B16.28	ASTM A234	WPB	

FLANGES

Component	Size	Rating	Standard	Material	Material Grade	Additional Requirements
Threaded Flange	½ - 6	Class 150	ASME B16.5	ASTM A105	N/A	
Socket-Weld Flange	½ - 2	Class 150	ASME B16.5	ASTM A105	N/A	
Weldneck Flange	½ - 24	Class 150	ASME B16.5	ASTM A105	N/A	
Slip-on Flange	½ - 24	Class 150	ASME B16.5	ASTM A105	N/A	
Backup Flange	½ - 24	Class 150	ASME B16.5	ASTM A105	N/A	

MECHANICAL FASTENERS

Component	Size	Standard	Material	Material Grade	Additional Requirements
Fasteners	½ - 1½	ASME B18.2.1	ASTM A193	B7-HH	Limited to 600°F, See Note 10.
Nuts	½ - 1½	ASME B18.2.2	ASTM A194	2H-HH	

Piping Specification 903	Date: September 17, 2014	Revision: 0	Page 1 of 1
--------------------------	--------------------------	-------------	-------------

DESIGN PARAMETERS

P-Spec	PS-903(A, B, C, D)						
Design Pressure (psig)	150	132	112	93	75	60	45
Design Temperature (°F)	73	90	100	110	120	130	140
Minimum Temperature (°F)	-20	-20	-20	-20	-20	-20	-20
Minimum Test Pressure (psig)	225	225	225	225	225	225	225
Maximum Test Pressure (psig)	250						

Calculation Reference:	00-00-CALC-M-0004-R0
Code of Reference:	AWWA
Fluid Service:	Water
Material:	PVC
Pressure Rating:	150 psi

GENERAL NOTES

Refer to General Notes 3, 9, 10, 13, 40-45.

ALLOWABLE PIPE MATERIALS

Component	Size	Rating	Standard	Material	Material Grade	Additional Requirements
Piping	4 - 12	Schedule Tables	AWWA C900	ASTM D1784	12454-A or B	
Piping	14 - 36	Schedule Tables	AWWA C905	ASTM D1784	12454-A or B	

REQUIRED SCHEDULES FOR NON-THREADED PIPE

P-Spec	Corrosion Allowance	Pipe Size	4	6	8	10	12	14	16	18	20	24	30	36
A	0.00	Schedule	18	18	18	18	18	26	26	26	26	26	26	26

FITTINGS

Component	Size	Rating	Standard	Material	Material Grade	Additional Requirements
PVC Fittings	4 – 8	Cl. 150 (DR 18)	AWWA C907	ASTM D1784	12454-A or 12454-B	Push-on
Ductile Iron Fittings	4 – 16	350	AWWA C153/A21.53	ASTM A536	DI	Push-on or Mechanical
Ductile Iron Fittings	4 – 36	350	AWWA C110/A21.10	ASTM A536	DI	Push-on or Mechanical
Grey Iron Fittings	4 - 36	150 or 250	AWWA C110/A21.10	A48	25 or 30	Push-on or Mechanical

FLANGES

Component	Size	Rating	Standard	Material	Material Grade	Additional Requirements
Ductile Iron Fittings	4 – 36	350	AWWA C110/A21.10	ASTM A536	DI	
Grey Iron Fittings	4 - 36	150 or 250	AWWA C110/A21.10	A48	25 or 30	

MECHANICAL FASTENERS

Component	Size	Standard	Material	Material Grade	Additional Requirements
Fasteners	¾ - 1½	ASME B18.2.1	ASTM A307	Grade A	See note 10.
Nuts	¾ - 1½	ASME B18.2.2	ASTM A563	Grade B	

Section REF References

Rev. 0, 9/17/2014

REF-3 ASME B31.3 Process Piping Guide

Piping Specification 904	Date: September 17, 2014	Revision: 0	Page 1 of 1
--------------------------	--------------------------	-------------	-------------

DESIGN PARAMETERS

P-Spec	PS-904
Design Pressure (psig)	250
Design Temperature (°F)	150
Minimum Temperature (°F)	0
Minimum Test Pressure (psig)	375
Maximum Test Pressure (psig)	400

Calculation Reference:	00-00-CALC-M-0004-R0
Code of Reference:	AWWA
Fluid Service:	Water
Material:	Ductile Iron
Pressure Rating:	250 psi

GENERAL NOTES

Refer to General Notes 3, 9, 10, 13, 41, 44, 46-50.

ALLOWABLE PIPE MATERIALS

Component	Size	Rating	Standard	Material	Material Grade	Additional Requirements
Piping	3 - 64	Schedule Tables	AWWA C151	ASTM A48	DI	
Piping	3 - 64	Schedule Tables	AWWA C115	ASTM A48/A536	DI	Threaded Ends

REQUIRED SCHEDULES FOR NON-THREADED PIPE

P-Spec	Corrosion Allowance	Pipe Size	3	4	6	88	10	12	14	16	18	20	24	30	36	42	48	54	60	64
A	0.00	Schedule	350	350	350	350	350	350	250	250	250	250	250	250	250	250	250	250	250	250

REQUIRED SCHEDULES FOR THREADED PIPE

P-Spec	Corrosion Allowance	Pipe Size	3	4	6	88	10	12	14	16	18	20	24	30	36	42	48	54	60	64
A	0.00	Schedule	53	53	53	53	53	53	53	53	53	53	53	53	53	53	53	53	53	53

FITTINGS

Component	Size	Rating	Standard	Material	Material Grade	Additional Requirements
Ductile Iron Push-on	3 - 48	250	AWWA C111/A21.11	ASTM A536	DI	
Ductile Iron Fittings	3 - 16	350	AWWA C153/A21.53	ASTM A536	DI	
Ductile Iron Fittings	3 - 48	350	AWWA C110/A21.10	ASTM A536	DI	
Grey Iron Fittings	3 - 48	250	AWWA C110/A21.10	A48	30	

FLANGES

Component	Size	Rating	Standard	Material	Material Grade	Additional Requirements
Ductile Iron Fittings	3 - 48	350	AWWA C110/A21.10	ASTM A536	DI	
Grey Iron Fittings	3 - 48	250	AWWA C110/A21.10	A48	30	
Ductile Iron Flanges	3 - 24	250	AWWA C115/A21.15	ASTM A536	DI	Threaded Flanges
Grey Iron Flanges	3 - 24	250	AWWA C115/A21.15	A48	30	Threaded Flanges

MECHANICAL FASTENERS

Component	Size	Standard	Material	Material Grade	Additional Requirements
Fasteners	5/8 - 1 1/2	ASME B18.2.1	ASTM A307	Grade A	See note 10.
Nuts	5/8 - 1 1/2	ASME B18.2.2	ASTM A563	Grade B	

APPENDIX B – FLUID SERVICE SHEETS

This appendix contains data on selecting the appropriate materials to be used in a specific fluid service. This data should be used with caution because it represents cases where the chemistry of the specified fluid is well understood. The recommendations made in the Fluid Service Sheets are one option based on economic and technical considerations. Other options may be technically acceptable. Questions about corrosion allowance values for a specific fluid service should be directed to ESM Pressure Safety Point-of-Contact. An index to the Fluid Service Sheets is provided below.

FLUID SERVICE SHEET REVISION CONTROL PAGE			
SERVICE	REVISION	PAGES	DESCRIPTION OF REVISION
Air (Breathing)	0	1	Original Issue
Air (Compressed/Plant)	0	1	Original Issue
Caustic	0	1	Original Issue
Diesel Fuel	0	1	Original Issue
Nitric Acid (0-65%)	0	1	Original Issue
Nitric Acid (0-95%)	0	1	Original Issue
Nitrogen (Cryogenic)	0	1	Original Issue
Oxalic Acid	0	1	Original Issue
Oxygen (Liquid or Gas)	0	1	Original Issue
Refrigerants	0	1	Original Issue
Steam (Low Pressure)	0	1	Original Issue
Steam (Medium Pressure)	0	1	Original Issue
Sulfuric Acid (0-100%)	0	1	Original Issue
Sulfuric Acid (70-100%)	0	1	Original Issue
Water (DI)	0	1	Original Issue
Water (Domestic)	0	1	Original Issue
Water (Heavy/Contaminated)	0	1	Original Issue
Water (Raw/Untreated)	0	1	Original Issue
Water (Service)	0	1	Original Issue

Fluid Service: Air (Breathing)	Page 1 of 1	Revision: 0	Date: 9/17/14
--------------------------------	-------------	-------------	---------------

GENERAL INFORMATION

Material	P-Spec	Corrosion Allowance (in)	Max Pressure (psi)	Max Temperature (°F)	Additional Requirements
Carbon Steel Pipe	PS-101B	0.031	200	200	
Stainless Steel Pipe	PS-200A	0	195	200	

GASKETS

Material	Flange Face Finish	Additional Requirements
Reinforced Teflon	125-250	

NOTES

- 1) See Appendix C for Pressure-Temperature Rating of Gaskets
- 2) Stainless steel is required downstream of the filter.
- 3) Piping runs can utilize butt welded, socket welded, or threaded connections.

VALVES

The valve ID numbering system is defined in Appendix D.

	Feature	Feature Specifications
Required Specification Features	1) Acceptable Standard	CV Code Valve
	2) Material	2-Bronze, 4-Carbon Steel (1), 5-Stainless Steel 304(L) (2), 6-Stainless Steel 316(L) (3)
	3) Pressure Class	1-150, P-Pressure Rated
	4) End Connection (4)	1-Flanged, 2-Socket Weld, 3-Butt Weld, 4-Threaded
	5) Type of Valve	BL-Ball, CB-Ball Check, GW-Solid Wedge Gate, TN-Needle Globe, TS-Standard Globe
Optional Specification Features	6) Valve Size	Specified as shown in the Example Valve ID Number by NPS
	7) Disc Material	A-Chromium (11-13%), C-Bronze, D-Stainless Steel
	8) Seat Material	A-Chromium (11-13%), D-Stainless Steel, O-Viton, P-EPDM
	9) Stem Material	A-Chromium (11-13%), B-Carbon Steel, C-Bronze, D-Stainless Steel
	10) Packing Material	A-Graphite, B-Teflon, D-Nylon, G-Viton, H-EPDM
	11) Body Gasket	B-Teflon, D-Nylon, G-Viton, H-EPDM

NOTES

- 1) ASTM A216WCB or A105
- 2) CF3, CF8, F304, or F304L
- 3) CF3M, CF8M, F316, F316L
- 4) Non welded end stainless steel valves pressure rating is based on the high carbon (non L) grade.

Fluid Service: Air (Compressed/Plant)	Page 1 of 1	Revision: 0	Date: 9/17/14
---------------------------------------	-------------	-------------	---------------

GENERAL INFORMATION

Material	P-Spec	Corrosion Allowance (in)	Max Pressure (psi)	Max Temperature (°F)	Additional Requirements
Carbon Steel Pipe	PS-101B	0.031	200	200	

GASKETS

Material	Flange Face Finish	Additional Requirements
NBR Bonded Aramid Fiber	125-250	

NOTES

- 1) See Appendix C for Pressure-Temperature Rating of Gaskets.
- 2) Piping runs can utilize butt welded, socket welded, or threaded connections.

VALVES

The valve ID numbering system is defined in Appendix D.

	Feature	Feature Specifications
Required Specification Features	1) Acceptable Standard	CV Code Valve
	2) Material	2-Bronze, 4-Carbon Steel (1)
	3) Pressure Class	1-150, P-Pressure Rated
	4) End Connection	1-Flanged, 2-Socket Weld, 3-Butt Weld, 4-Threaded
	5) Type of Valve	BL-Ball, CB-Ball Check, GW-Solid Wedge Gate, TN-Needle Globe, TS-Standard Globe
Optional Specification Features	6) Valve Size	Specified as shown in the Example Valve ID Number by NPS
	7) Disc Material	A-Chromium (11-13%), C-Bronze
	8) Seat Material	A-Chromium (11-13%), O-Viton, P-EPDM
	9) Stem Material	A-Chromium (11-13%), B-Carbon Steel, C-Bronze
	10) Packing Material	A-Graphite, B-Teflon, D-Nylon, G-Viton, H-EPDM
	11) Body Gasket	B-Teflon, D-Nylon, G-Viton, H-EPDM

NOTES

- 1) ASTM A216WCB or A105

Fluid Service: Caustic Soda (0 – 50% NaOH)	Page 1 of 1	Revision: 0	Date: 9/17/14
--	-------------	-------------	---------------

GENERAL INFORMATION

Material	P-Spec	Corrosion Allowance (in)	Max Pressure (psi)	Max Temperature (°F)	Additional Requirements
Carbon Steel Pipe	PS-101B	0.031	200	200	

GASKETS

Material	Flange Face Finish	Additional Requirements
NBR Bonded	125-250	May be used with Flat Face Flanges

NOTES

- 1) See Appendix C for Pressure-Temperature Rating of Gaskets.
- 2) Material selection in this fluid service is critical and changes should be made with caution.
- 3) Flanged connections should be minimized and only used when required for component and equipment connections.
- 4) Threaded connections should only be allowed for instrument connections.
- 5) Socket welded connections are not permitted for this fluid service.
- 6) Welds and cold bends are required to be stress relieved under the conditions in the following table.

Concentration NaOH vs. Temperature Requiring Stress Relief

Concentration (% NaOH)	Temperature (°F)
0	180
20	160
30	140
50	115

VALVES

The valve ID numbering system is defined in Appendix D.

	Feature	Feature Specifications
Required Specification Features	1) Acceptable Standard	CV Code Valve
	2) Material	4-Carbon Steel (1), 5-Stainless Steel 304(L) (2), 6-Stainless Steel 316(L) (3), 7-Monel
	3) Pressure Class	1-150, P-Pressure Rated
	4) End Connection	1-Flanged, 3-Butt Weld
	5) Type of Valve	BL-Ball, CL-Lift Check, CT-Tilting Disk Check, GW-Solid Wedge Gate
Optional Specification Features	6) Valve Size	Specified as shown in the Example Valve ID Number by NPS
	7) Disc Material	A-Chromium (11-13%) (5), D-Stainless Steel, E-Monel
	8) Seat Material	A-Chromium (11-13%) (5), D-Stainless Steel, E-Monel, J-Teflon, P-EPDM
	9) Stem Material	A-Chromium (11-13%) (5), D-Stainless Steel, E-Monel
	10) Packing Material	A-Graphite, B-Teflon, H-EPDM
	11) Body Gasket	A-Graphite, B-Teflon, H-EPDM

NOTES

- 1) ASTM A216WCB or A105
- 2) CF3, CF8, F304, or F304L
- 3) CF3M, CF8M, F316, F316L

Section REF References

Rev. 0, 9/17/2014

REF-3 ASME B31.3 Process Piping Guide

- 4) Non-welded-end stainless steel valves pressure rating is based on the high carbon (non L) grade.
- 5) Limit Chromium (11 – 13%) to 100° F.

Fluid Service: Diesel Fuel	Page 1 of 1	Revision: 0	Date: 9/17/14
----------------------------	-------------	-------------	---------------

GENERAL INFORMATION

Material	P-Spec	Corrosion Allowance (in)	Max Pressure (psi)	Max Temperature (°F)	Additional Requirements
Carbon Steel Pipe	PS-101B	0.031	50	120	Socket or Buttweld Runs

GASKETS

Material	Flange Face Finish	Additional Requirements
Spiral Wound Teflon Fill	125-250	Low Stress Style

NOTES

- 1) See Appendix C for Pressure-Temperature Rating of Gaskets.
- 2) Material selection in this fluid service is critical and changes should be made with caution.
- 3) Flanged connections should be minimized and only used when required for component and equipment connections.
- 4) Piping runs can utilize butt welded, socket welded, or threaded connections.

VALVES

The valve ID numbering system is defined in Appendix D.

	Feature	Feature Specifications
Required Specification Features	1) Acceptable Standard	CV Code Valve
	2) Material	4-Carbon Steel (1), 5-Stainless Steel 304(L) (2), 6-Stainless Steel 316(L) (3), 7-Monel
	3) Pressure Class	1-150, P-Pressure Rated
	4) End Connection	1-Flanged , 3-Butt Weld
	5) Type of Valve	BL-Ball, CL-Lift Check, CT-Tilting Disk Check, GW-Solid Wedge Gate
Optional Specification Features	6) Valve Size	Specified as shown in the Example Valve ID Number by NPS
	7) Disc Material	A-Chromium (11-13%), D-Stainless Steel
	8) Seat Material	A-Chromium (11-13%), D-Stainless Steel, J-Teflon
	9) Stem Material	A-Chromium (11-13%), D-Stainless Steel
	10) Packing Material	A-Graphite, B-Teflon
	11) Body Gasket	A-Graphite, B-Teflon

NOTES

- 1) ASTM A216WCB or A105
- 2) CF3, CF8, F304, or F304L
- 3) CF3M, CF8M, F316, F316L
- 4) Non welded end stainless steel valves pressure rating is based on the high carbon (non L) grade.

Fluid Service: Nitric Acid (0 – 65%)	Page 1 of 1	Revision: 0	Date: 9/17/14
--------------------------------------	-------------	-------------	---------------

GENERAL INFORMATION

Material	P-Spec	Corrosion Allowance (in)	Max Pressure (psi)	Max Temperature (°F)	Additional Requirements
Stainless Steel	PS-200D	0.08	195	200 (1)	Use only low carbon (L grade) material

GASKETS

Material	Flange Face Finish	Additional Requirements
Spiral Wound Teflon Fill	125-250	Low Stress Style

NOTES

- 1) Temperature limits are set to control corrosion.
- 2) Piping wall thickness should be examined on a periodic basis.
- 3) See Appendix C for Pressure-Temperature Rating of Gaskets.
- 4) Material selection in this fluid service is critical and changes should be made with caution.
- 5) Flanged connections should be minimized and only used when required for component and equipment connections.
- 6) Threaded connections should only be allowed for instrument connections.
- 7) Socket welded connections are not permitted for this fluid service.
- 8) Corrosion evaluated materials are recommended for this fluid service.

VALVES

The valve ID numbering system is defined in Appendix D.

	Feature	Feature Specifications
Required Specification Features	1) Acceptable Standard	CV Code Valve
	2) Material	5-Stainless Steel 304(L) (1), 6-Stainless Steel 316(L) (2)
	3) Pressure Class	1-150
	4) End Connection	1-Flanged , 3-Butt Weld
	5) Type of Valve	BL-Ball, CB-Ball Check, CL-Lift Check, GW-Solid Wedge Gate
Optional Specification Features	6) Valve Size	Specified as shown in the Example Valve ID Number by NPS
	7) Disc Material	D-Stainless Steel,
	8) Seat Material	D-Stainless Steel, J-Teflon, O-Viton
	9) Stem Material	D-Stainless Steel
	10) Packing Material	A-Graphite
	11) Body Gasket	A-Graphite, B-Teflon, G-Viton

NOTES

- 1) CF3, CF8, F304, or F304L
- 2) CF3M, CF8M, F316, F316L

Fluid Service: Nitric Acid (0-95%)	Page 1 of 1	Revision: 0	Date: 9/17/14
------------------------------------	-------------	-------------	---------------

GENERAL INFORMATION

Material	P-Spec	Corrosion Allowance (in)	Max Pressure (psi)	Max Temperature (°F)	Additional Requirements
Stainless Steel	PS-200D	0.08	230	100 (1)	Use only low carbon (L grade) material

GASKETS

Material	Flange Face Finish	Additional Requirements
Spiral Wound Teflon Fill	125-250	Low Stress Style

NOTES

- 1) Temperature limits are set to control corrosion.
- 2) Piping wall thickness should be examined on a periodic basis.
- 3) See Appendix C for Pressure-Temperature Rating of Gaskets.
- 4) Material selection in this fluid service is critical and changes should be made with caution.
- 5) Flanged connections should be minimized and only used when required for component and equipment connections.
- 6) Threaded connections should only be allowed for instrument connections.
- 7) Socket welded connections are not permitted for this fluid service.
- 8) Corrosion evaluated materials are recommended for this fluid service

VALVES

The valve ID numbering system is defined in Appendix D.

	Feature	Feature Specifications
Required Specification Features	1) Acceptable Standard	CV Code Valve
	2) Material	5-Stainless Steel 304(L) (1), 6-Stainless Steel 316(L) (2)
	3) Pressure Class	1-150
	4) End Connection	1-Flanged (8), 3-Butt Weld
	5) Type of Valve	BL-Ball, CB-Ball Check, CL-Lift Check, GW-Solid Wedge Gate
Optional Specification Features	6) Valve Size	Specified as shown in the Example Valve ID Number by NPS
	7) Disc Material	D-Stainless Steel,
	8) Seat Material	D-Stainless Steel, J-Teflon, O-Viton
	9) Stem Material	D-Stainless Steel
	10) Packing Material	A-Graphite
	11) Body Gasket	A-Graphite, B-Teflon, G-Viton

NOTES

- 1) F304L
- 2) F316L

Section REF References

Rev. 0, 9/17/2014

REF-3 ASME B31.3 Process Piping Guide

Fluid Service: Nitrogen (cryogenic)	Page 1 of 1	Revision: 0	Date: 9/17/14
-------------------------------------	-------------	-------------	---------------

GENERAL INFORMATION

Material	P-Spec	Corrosion Allowance (in)	Max Pressure (psi)	Max Temperature (°F)	Additional Requirements
Stainless Steel	PS-200	0.00	100	See P-spec	

GASKETS

Material	Flange Face Finish	Additional Requirements
Spiral Wound/Teflon Fill	125-250	Style Low Stress (LS)

NOTES

- 1) See Appendix C for Pressure-Temperature Rating of Gaskets.
- 2) Material selection in this fluid service is critical and changes should be made with caution.
- 3) Flanged connections should be minimized and only used when required for component and equipment connections.
- 4) Threaded connections should only be allowed for instrument connections.
- 5) The minimum temperature may govern the design of this piping system and require impact testing for certain material and welding procedures.

VALVES

The valve ID numbering system is defined in Appendix D.

	Feature	Feature Specifications
Required Specification Features	1) Acceptable Standard	CV Code Valve
	2) Material	5-Stainless Steel 304(L) (1)
	3) Pressure Class	1-150, P-Pressure Rated
	4) End Connection	1-Flanged, 3-Butt Weld
	5) Type of Valve	BL-Ball, CB-Ball Check, CL-Lift Check, CS-Swing Check, DV-Diaphragm, GW-Solid Wedge Gate
Optional Specification Features	6) Valve Size	Specified as shown in the Example Valve ID Number by NPS
	7) Disc Material	D-Stainless Steel,
	8) Seat Material	D-Stainless Steel, J-Teflon, O-Viton
	9) Stem Material	D-Stainless Steel
	10) Packing Material	A-Graphite
	11) Body Gasket	A-Graphite, B-Teflon, G-Viton

NOTES

- 1) CF3, CF8, F304, or F304L

Section REF References

Rev. 0, 9/17/2014

REF-3 ASME B31.3 Process Piping Guide

Fluid Service: Oxalic Acid (0-100%)	Page 1 of 1	Revision: 0	Date: 9/17/14
-------------------------------------	-------------	-------------	---------------

GENERAL INFORMATION

Material	P-Spec	Corrosion Allowance (in)	Max Pressure (psi)	Max Temperature (°F)	Additional Requirements
Stainless Steel	PS-201B	0.03	100	125 (1)	

GASKETS

Material	Flange Face Finish	Additional Requirements
Spiral Wound/Teflon Fill	125-250	Style Low Stress (LS)

NOTES

- 1) Temperature limits are set to control corrosion.
- 2) Piping wall thickness should be examined on a periodic basis.
- 3) See Appendix C for Pressure-Temperature Rating of Gaskets.
- 4) Material selection in this fluid service is critical and changes should be made with caution.
- 5) Flanged connections should be minimized and only used when required for component and equipment connections.
- 6) Threaded connections should only be allowed for instrument connections.
- 7) Socket welded connections are not permitted for this fluid service.
- 8) Corrosion evaluation of the materials is recommended of this fluid service.

VALVES

The valve ID numbering system is defined in Appendix D.

	Feature	Feature Specifications
Required Specification Features	1) Acceptable Standard	CV Code Valve
	2) Material	6-Stainless Steel 316(L) (1), 8-Alloy 20
	3) Pressure Class	1-150, P-Pressure Rated
	4) End Connection	1-Flanged , 3-Butt Weld
	5) Type of Valve	BL-Ball, CB-Ball Check, CL-Lift Check, CS-Swing Check, DV-Diaphragm, GW-Solid Wedge Gate
Optional Specification Features	6) Valve Size	Specified as shown in the Example Valve ID Number by NPS
	7) Disc Material	D-Stainless Steel, F-Alloy 20
	8) Seat Material	D-Stainless Steel, F-Alloy 20, J-Teflon, O-Viton
	9) Stem Material	D-Stainless Steel, F-Alloy 20
	10) Packing Material	A-Graphite
	11) Body Gasket	A-Graphite, B-Teflon, G-Viton

NOTES

- 1) CF8, CF8M, F316, F316L

Section REF References

Rev. 0, 9/17/2014

REF-3 ASME B31.3 Process Piping Guide

Fluid Service: Oxygen (gas or liquid)	Page 1 of 1	Revision: 0	Date: 9/17/14
---------------------------------------	-------------	-------------	---------------

GENERAL INFORMATION

Material	P-Spec	Corrosion Allowance (in)	Max Pressure (psi)	Max Temperature (°F)	Additional Requirements
Stainless Steel	PS-201B	0.03	100	See P-spec	

GASKETS

Material	Flange Face Finish	Additional Requirements
Spiral Wound/Teflon Fill	125-250	Style Low Stress (LS)

NOTES

- 1) See Appendix C for Pressure-Temperature Rating of Gaskets.
- 2) Material selection in this fluid service is critical and changes should be made with caution.
- 3) Components with ferrous materials shall not be used in this fluid service.
- 4) Components and piping in this system shall be cleaned prior to start up. See Appendix K for cleaning guidance.
- 5) Flanged connections should be minimized and only used when required for component and equipment connections.
- 6) Threaded connections should only be allowed for instrument connections.

VALVES

The valve ID numbering system is defined in Appendix D.

	Feature	Feature Specifications
Required Specification Features	1) Acceptable Standard	CV Code Valve
	2) Material	6-Stainless Steel 316(L) (1)
	3) Pressure Class	1-150, P-Pressure Rated
	4) End Connection	1-Flanged, 3-Butt Weld
	5) Type of Valve	BL-Ball, CB-Ball Check, CL-Lift Check, CS-Swing Check, DV-Diaphragm, GW-Solid Wedge Gate
Optional Specification Features	6) Valve Size	Specified as shown in the Example Valve ID Number by NPS
	7) Disc Material	D-Stainless Steel,
	8) Seat Material	D-Stainless Steel, J-Teflon, O-Viton
	9) Stem Material	D-Stainless Steel
	10) Packing Material	A-Graphite
	11) Body Gasket	A-Graphite, B-Teflon, G-Viton

NOTES

- 1) CF8, CF8M, F316, F316L

Fluid Service: Refrigerant	Page 1 of 1	Revision: 0	Date: 9/17/14
----------------------------	-------------	-------------	---------------

GENERAL INFORMATION

Material	P-Spec	Corrosion Allowance (in)	Max Pressure (psi)	Max Temperature (°F)	Additional Requirements
Copper Tube	PS-403	0	400	See P-Spec	Braze all connections

GASKETS

Material	Flange Face Finish	Additional Requirements
EPDM	250-500	For Full Face Applications ≤ 100 psi, -20° F minimum temp.

NOTES

- 1) Full face gaskets are required for flat face flanges.
- 2) Flanges should only be used for fit-up flanged components in copper piping systems
- 3) See Appendix C for Pressure-Temperature Rating of Gaskets.
- 4) There are many suitable materials for this fluid service. The selections below are strictly for guidance.

VALVES

The valve ID numbering system is defined in Appendix D.

	Feature	Feature Specifications
Required Specification Features	1) Acceptable Standard	CV Code Valve
	2) Material	1-Brass
	3) Pressure Class	2-300
	4) End Connection	6-Solder (Brazed), 9-Compression
	5) Type of Valve	BL-Ball, CB-Ball Check, CP-Poppet Check, TN-Needle Globe, TS-Standard Globe, V3-Three Way Valve (1)
Optional Specification Features	6) Valve Size	Specified as shown in the Example Valve ID Number by NPS
	7) Disc Material	H-Brass,
	8) Seat Material	D-Stainless Steel, H-Brass, J-Teflon
	9) Stem Material	D-Stainless Steel, H-Brass
	10) Packing Material	A-Graphite, B-Teflon
	11) Body Gasket	A-Graphite, B-Teflon

NOTES

- 1) Specify port requirement

Fluid Service: Steam (Low Pressure)	Page 1 of 1	Revision: 0	Date: 9/17/14
-------------------------------------	-------------	-------------	---------------

GENERAL INFORMATION

Material	P-Spec	Corrosion Allowance (in)	Max Pressure (psi)	Max Temperature (°F)	Additional Requirements
Carbon Steel	PS-102C	0.0625	285	See P-spec	

GASKETS

Material	Flange Face Finish	Additional Requirements
Spiral Wound/Graphite Fill	125-250	Style Low Stress (LS)

NOTES

- 1) See Appendix C for Pressure-Temperature Rating of Gaskets.
- 2) Piping runs can utilize butt welded, socket welded, or threaded connections.

VALVES

The valve ID numbering system is defined in Appendix D.

	Feature	Feature Specifications
Required Specification Features	1) Acceptable Standard	CV Code Valve
	2) Material	4-Carbon Steel (1)
	3) Pressure Class	1-150
	4) End Connection	1-Flanged, 2-Socket Weld, 3-Butt Weld, 4-Threaded
	5) Type of Valve	BL-Ball, CL-Lit Check, CS-Swing Check, GF-Flex/Split Wedge Gate, TS-Standard Globe
Optional Specification Features	6) Valve Size	Specified as shown in the Example Valve ID Number by NPS
	7) Disc Material	A-Chromium (11-13%)
	8) Seat Material	A-Chromium (11-13%), B-Stellite (Hard Face)
	9) Stem Material	A-Chromium (11-13%)
	10) Packing Material	A-Graphite
	11) Body Gasket	A-Graphite

NOTES

- 1) ASTM A216WCB or A105

Fluid Service: Steam (Medium Pressure)	Page 1 of 1	Revision: 0	Date: 9/17/14
--	-------------	-------------	---------------

GENERAL INFORMATION

Material	P-Spec	Corrosion Allowance (in)	Max Pressure (psi)	Max Temperature (°F)	Additional Requirements
Carbon Steel	PS-103C	0.0625	600	See P-spec	

GASKETS

Material	Flange Face Finish	Additional Requirements
Spiral Wound/Graphite Fill	125-250	Style Low Stress (LS)

NOTES

- 1) See Appendix C for Pressure-Temperature Rating of Gaskets.
- 2) Piping runs can utilize butt welded, socket welded, or threaded connections.

VALVES

The valve ID numbering system is defined in Appendix D.

	Feature	Feature Specifications
Required Specification Features	1) Acceptable Standard	CV Code Valve
	2) Material	4-Carbon Steel (1)
	3) Pressure Class	1-150
	4) End Connection	1-Flanged, 2-Socket Weld, 3-Butt Weld, 4-Threaded
	5) Type of Valve	BL-Ball, CL-Lift Check, CS-Swing Check, GF-Flex/Split Wedge Gate, TS-Standard Globe
Optional Specification Features	6) Valve Size	Specified as shown in the Example Valve ID Number by NPS
	7) Disc Material	A-Chromium (11-13%)
	8) Seat Material	A-Chromium (11-13%), B-Stellite (Hard Face)
	9) Stem Material	A-Chromium (11-13%)
	10) Packing Material	A-Graphite
	11) Body Gasket	A-Graphite

NOTES

- 1) ASTM A216WCB or A105

Section REF References

Rev. 0, 9/17/2014

REF-3 ASME B31.3 Process Piping Guide

Fluid Service: Sulfuric Acid (0-100%)	Page 1 of 1	Revision: 0	Date: 9/17/14
---------------------------------------	-------------	-------------	---------------

GENERAL INFORMATION

Material	P-Spec	Corrosion Allowance (in)	Max Pressure (psi)	Max Temperature (°F)	Additional Requirements
Hastelloy C-276	PS-300D	0.095	100	150 (1)	
Alloy 20	PS-302D	0.07	100	150 (1)	

GASKETS

Material	Flange Face Finish	Additional Requirements
Spiral Wound/Teflon Fill	125-250	Style Low Stress (LS)

NOTES

- 1) Temperature limits are set to control corrosion.
- 2) Piping wall thickness should be examined on a periodic basis.
- 3) See Appendix C for Pressure-Temperature Rating of Gaskets.
- 4) Material selection in this fluid service is critical and changes should be made with caution.
- 5) Flanged connections should be minimized and only used when required for component and equipment connections.
- 6) Threaded connections should only be allowed for instrument connections.
- 7) Socket welded connections are not permitted for this fluid service.

VALVES

The valve ID numbering system is defined in Appendix D.

	Feature	Feature Specifications
Required Specification Features	1) Acceptable Standard	CV Code Valve
	2) Material	8-Alloy 20, 9-Hastelloy
	3) Pressure Class	1-150, P-Pressure Rated
	4) End Connection	1-Flanged , 3-Butt Weld
	5) Type of Valve	BL-Ball, CB-Ball Check, CL-Lift Check, CS-Swing Check, DV-Diaphragm, GW-Solid Wedge Gate
Optional Specification Features	6) Valve Size	Specified as shown in the Example Valve ID Number by NPS
	7) Disc Material	F-Alloy 20, G-Hastelloy
	8) Seat Material	F-Alloy 20, G-Hastelloy, O-Viton
	9) Stem Material	F-Alloy 20, G-Hastelloy
	10) Packing Material	A-Graphite, B-Teflon, G-Viton
	11) Body Gasket	A-Graphite, B-Teflon, G-Viton

NOTES

Section REF References

Rev. 0, 9/17/2014

REF-3 ASME B31.3 Process Piping Guide

Fluid Service: Sulfuric Acid (70-100%)	Page 1 of 1	Revision: 0	Date: 9/17/14
--	-------------	-------------	---------------

GENERAL INFORMATION

Material	P-Spec	Corrosion Allowance (in)	Max Pressure (psi)	Max Temperature (°F)	Additional Requirements
Carbon Steel	PS-101D	0.125	100	100 (1)	3 FPS>Fluid Velocity>1 FPS

GASKETS

Material	Flange Face Finish	Additional Requirements
Spiral Wound/Teflon Fill	125-250	Style Low Stress (LS)

NOTES

- 1) Temperature limits are set to control corrosion.
- 2) Piping wall thickness should be examined on a periodic basis.
- 3) See Appendix C for Pressure-Temperature Rating of Gaskets.
- 4) Material selection in this fluid service is critical and changes should be made with caution.
- 5) Flanged connections should be minimized and only used when required for component and equipment connections.
- 6) Threaded connections should only be allowed for instrument connections.
- 7) Socket welded connections are not permitted for this fluid service.

VALVES

The valve ID numbering system is defined in Appendix D.

	Feature	Feature Specifications
Required Specification Features	1) Acceptable Standard	CV Code Valve
	2) Material	4, Carbon Steel (1), 8-Alloy 20, 9-Hastelloy
	3) Pressure Class	1-150, P-Pressure Rated
	4) End Connection	1-Flanged, 3-Butt Weld
	5) Type of Valve	BL-Ball, CB-Ball Check, CL-Lift Check, CS-Swing Check, DV-Diaphragm, GW-Solid Wedge Gate
Optional Specification Features	6) Valve Size	Specified as shown in the Example Valve ID Number by NPS
	7) Disc Material	F-Alloy 20, G-Hastelloy
	8) Seat Material	F-Alloy 20, G-Hastelloy, O-Viton
	9) Stem Material	F-Alloy 20, G-Hastelloy
	10) Packing Material	A-Graphite, B-Teflon, G-Viton
	11) Body Gasket	A-Graphite, B-Teflon, G-Viton

NOTES

- 1) ASTM A216WCB or A105

Section REF References

Rev. 0, 9/17/2014

REF-3 ASME B31.3 Process Piping Guide

Fluid Service: Water (DI)	Page 1 of 1	Revision: 0	Date: 9/17/14
---------------------------	-------------	-------------	---------------

GENERAL INFORMATION

Material	P-Spec	Corrosion Allowance (in)	Max Pressure (psi)	Max Temperature (°F)	Additional Requirements
Stainless Steel Pipe	PS-200B	0.03	230	See P-Spec	
PVC	PS-500	0	150	See P-Spec	For Laboratory Applications (3)

GASKETS

Material	Flange Face Finish	Additional Requirements
Reinforced Teflon	125-250	
EPDM	250-500	For Full Face Applications ≤ 100 psi

NOTES

- 1) Use only full face gaskets with flat face flanges.
- 2) See Appendix C for Pressure-Temperature Rating of Gaskets.
- 3) To ensure purity of DI water for chemical metallurgical research, all wetted parts of the piping system, including components, must be non-metallic. The use of non-metallic valves would require the qualification of unlisted components.

VALVES

The valve ID numbering system is defined in Appendix D.

	Feature	Feature Specifications
Required Specification Features	1) Acceptable Standard	CV Code Valve
	2) Material	5-Stainless Steel (1), 6-Stainless Steel (2)
	3) Pressure Class	1-150, P-Pressure Rated
	4) End Connection	1-Flanged, 2-Socket Weld, 3-Butt Weld, 4-Threaded
	5) Type of Valve	BL-Ball, CB-Ball Check, GW-Solid Wedge Gate, TN-Needle Globe, TS-Standard Globe
Optional Specification Features	6) Valve Size	Specified as shown in the Example Valve ID Number by NPS
	7) Disc Material	A-Chromium (11-13%), C-Bronze, D-Stainless Steel, O-Viton, P-EPDM
	8) Seat Material	A-Chromium (11-13%), D-Stainless Steel, O-Viton, P-EPDM
	9) Stem Material	A-Chromium (11-13%), B-Carbon Steel, C-Bronze, D-Stainless Steel
	10) Packing Material	A-Graphite, B-Teflon, D-Nylon, G-Viton, H-EPDM
	11) Body Gasket	B-Teflon, D-Nylon, G-Viton, H-EPDM

NOTES

- 1) CF3, CF8, F304, or F304L
- 2) CF8, CF8M, F316, F316L

Fluid Service: Water (Domestic)	Page 1 of 1	Revision: 0	Date: 9/17/14
---------------------------------	-------------	-------------	---------------

GENERAL INFORMATION

Material	P-Spec	Corrosion Allowance (in)	Max Pressure (psi)	Max Temperature (°F)	Additional Requirements
Carbon Steel	PS-101B	0.031	200	See P-Spec	
PVC	PS-903	0	150	See P-Spec	For Buried Applications
PVC	PS-500	0	200	See P-Spec	

GASKETS

Material	Flange Face Finish	Additional Requirements
Reinforced Teflon	125-250	
EPDM	250-500	For Full Face Applications ≤ 100 psi.

NOTES

- 1) Use only Full Face gaskets with Flat Face Flanges.
- 2) Gaskets in push-on joints should be per the piping manufacturer's standard.
- 3) See Appendix C for Pressure-Temperature Rating of Gaskets.

VALVES

The valve ID numbering system is defined in Appendix D.

There are many suitable materials for this fluid service. Selections may be based on owner preference

Section REF References

Rev. 0, 9/17/2014

REF-3 ASME B31.3 Process Piping Guide

Fluid Service: Water (Heavy/Contaminated)	Page 1 of 1	Revision: 0	Date: 9/17/14
---	-------------	-------------	---------------

GENERAL INFORMATION

Material	P-Spec	Corrosion Allowance (in)	Max Pressure (psi)	Max Temperature (°F)	Additional Requirements
Stainless Steel Pipe	PS-200A	0.0	200	See P-Spec	

GASKETS

Material	Flange Face Finish	Additional Requirements
Spiral Wound/Graphite Fill	125-250	

NOTES

- 1) See Appendix C for Pressure-Temperature Rating of Gaskets.
- 2) Material selection in this fluid service is critical and changes should be made with caution.
- 3) Flanged connections should be minimized and only used when required for component and equipment connections.
- 4) Threaded connections should only be allowed for instrument connections.
- 5) Socket welded connections are not permitted for this fluid service.

VALVES

The valve ID numbering system is defined in Appendix D.

	Feature	Feature Specifications
Required Specification Features	1) Acceptable Standard	CV Code Valve
	2) Material	5-Stainless Steel 304/304L (1), 6-Stainless Steel 316/316L (2)
	3) Pressure Class	0-125, 1-150, P-Pressure Rated
	4) End Connection	1-Flanged (4), 3-Butt Weld
	5) Type of Valve	BL-Ball, CB-Ball Check, CL-Lift Check, CS-Swing Check, GW-Solid Wedge Gate, TS-Standard Globe
Optional Specification Features	6) Valve Size	Specified as shown in the Example Valve ID Number by NPS
	7) Disc Material	D-Stainless Steel
	8) Seat Material	D-Stainless Steel, R-UHMWPE
	9) Stem Material	D-Stainless
	10) Packing Material	A-Graphite, R -UHMWPE
	11) Body Gasket	A-Graphite, R-UHMWPE

NOTES

- 1) CF3, CF8, F304, or F304L
- 2) CF8, CF8M, F316, F316L

Fluid Service: Water (Raw/Untreated)	Page 1 of 1	Revision: 0	Date: 9/17/14
--------------------------------------	-------------	-------------	---------------

GENERAL INFORMATION

Material	P-Spec	Corrosion Allowance (in)	Max Pressure (psi)	Max Temperature (°F)	Additional Requirements
Carbon Steel Pipe	PS-101B	0.031	285	See P-Spec	Cement Lined (1)
PVC	PS-903	0	150	See P-Spec	For buried applications
PVC	PS-500	0	150	100	
CPVC	PS-501	0	150	See P-Spec	

GASKET

Material	Flange Face Finish	Additional Requirements
Reinforced Teflon	125-250	Carbon steel piping systems
EPDM	250-500	For Full Face Applications ≤ 100 psi.

NOTES

- 1) Cement Lining should be per AWWA C205
- 2) See Appendix C for Pressure-Temperature Rating of Gaskets.
- 3) Gaskets in push-on joints should be per the piping manufacturer's standard.
- 5) No wetted parts should be composed of copper or alloys that are high in copper content.

VALVES

The valve ID numbering system is defined in Appendix D.

There are many suitable materials for this fluid service. Selections may be based on owner preference

Fluid Service: Water (Service)	Page 1 of 1	Revision: 0	Date: 9/17/14
--------------------------------	-------------	-------------	---------------

GENERAL INFORMATION

Material	P-Spec	Corrosion Allowance (in)	Max Pressure (psi)	Max Temperature (°F)	Additional Requirements
Carbon Steel Pipe	PS-101C	0.063	285	See P-Spec	
PVC	PS-903	0	150	See P-Spec	For buried applications
PVC	PS-500	0	150	100	
CPVC	PS-501	0	150	See P-Spec	

GASKETS

Material	Flange Face Finish	Additional Requirements
Reinforced Teflon	125-250	Carbon steel piping systems
EPDM	250-500	For Full Face Applications ≤ 100 psi.

NOTES

- 1) Use only full face gaskets with flat face flanges.
- 2) See Appendix C for Pressure-Temperature Rating of Gaskets.
- 3) Gaskets in push-on joints should be per the piping manufacturer's standard.

VALVES

The valve ID numbering system is defined in Appendix D.

There are many suitable materials for this fluid service. Selections may be based on owner preference

APPENDIX C – MATERIALS SELECTION

This appendix contains information on selecting gaskets and materials for pipe, fittings, valve bodies, and packing. There are many factors that influence the proper selection of a material. These factors include the pressure/temperature rating of the piping system and gasket material compatibility with the fluid service. The following general guidance is provided for material selection.

The following information provides a general description of some common materials and the service where they might be used. This information is not definitive or all-inclusive. For severe fluid services, additional research on material acceptability is required, and in all cases the final responsibility of material selection resides with the cognizant engineering organization.

Gaskets

The gaskets listed in Table 1 are the most commonly used gasket materials at the LANL. Other gasket materials are used in special applications. The use of these other gasket materials is acceptable when properly rated for pressure, temperature and compatibility with the fluid service.

Gaskets must be able to:

- a) Maintain integrity during handling and installation.
- b) Be sufficiently deformable to flow into imperfections on the seating surfaces to create an initial seal.
- c) Have sufficient strength to resist crushing under the applied load and defy rupture under pressure.
- d) Chemically resist fluid under all temperatures and pressures.
- e) Be strong enough to maintain the seal, tough enough to withstand creep relaxation, and resilient enough to provide recovery during normal operation including thermal cycling and vibration.
- f) Never promote corrosion of the seating surface.
- g) Be impermeable to the fluid being handled.
- h) Be sufficiently resistant to radiation, if present, to perform its function.

Guidance for selection of gaskets in specific fluid services is provided in Appendix B “Fluid Service Sheets.”

Refer to Table 1 for the pressure/temperature rating of some commonly used gasket materials. Refer to Appendix E for torquing requirements.

Table 1 - Gasket Material Pressure/Temperature Ratings

Gasket Material	Maximum Pressure	Minimum Temperature	Maximum Temperature	Comments
Nitrile (NBR, Buna-N)	150 psi	-20°F	250°F	
Neoprene (35 IRHD, 60 IRHD, 75 IRHD)	150 psi	-20°F	212°F	
EPDM (70 IRHD)	150 psi	-20°F	350°F	
Graphite	2000 psi	-300°F	850°F	Note 1
Viton (60 IRHD, 80 IRHD)	150 psi	-20°F	392°F	
Reinforced Teflon	800 psi	-350°F	550°F	Note 2
NBR/Synthetic Fiber (Inorganic Fiber)	1200 psi	-40°F	550°F	
EPDM/Aramid Fiber	1200 psi	-40°F	550°F	Note 3
NBR/Aramid Fiber	1000 psi	-40°F	550°F	Note 3
SBR/Aramid Fiber	1200 psi	-40°F	550°F	Note 3
Spiral Wound - Teflon	Class 2500	-350°F	500°F	
Spiral Wound - Graphite	Class 2500	-300°F	850°F	

General Notes:

- A. Non-Spiral Wound Gaskets should be specified in thicknesses of either 1/16" or 1/8". The thinner (1/16") is preferred.
- B. Pressure and temperature ratings are generic based on available manufacturer's data. Refer to the Garlock catalog, the Lamons catalog, and the Flexitallic catalog. Specific ratings for these and other company products may vary, and cautions should be exercised when specifying gaskets close to the limiting conditions. Gaskets with pressure and temperature ratings higher than those identified above are available, and should be specified on a case-by-case basis. Other gasket materials may be available and more suitable for some services. The ESM Pressure Safety Point-of-Contact can provide information to the specifying engineer in some cases.
- C. Virgin Teflon material exhibits poor cold flow and creep properties for gaskets, and the use of gaskets made from un-reinforced Teflon should be avoided. Reinforced Teflon is a Teflon material in which some fiber, weave, braid, etc. is mixed or sandwiched in the Teflon to provide better strength and cold flow properties.
- D. Effects of ionizing radiation must be considered in radioactive services or environments.
 - a. A general rule for elastomers used for sealing is that an accumulated radiation dose of 10^6 rads represents the point at which elastomers may be losing their ability to maintain a seal, particularly in a dynamic application where resiliency is required. Radioactive gas (e.g., tritium) that can diffuse into seal materials can accelerate damage rates.
 - b. Materials containing polytetrafluoroethylene (PTFE) or trade name Teflon™ have significantly lower thresholds to radiation damage. A dosage of 1.7×10^4 rads causes substantial damage. Common trade and commercial names of PTFE-like materials include: Algoflon, Duroid, Fluon, Fluorocomp, Gortex, Halon TFE, Kalrez perfluoroelastomer, Kel-F polychlorotrifluoroethylene, Neoflon, Polycomp, Polyflon and Teflon.
 - c. When radiation exposure can be adequately predicted and controlled below threshold damage levels, select a polymer based on expected environmental conditions including dose. Polymers with relatively higher radiation resistance include Vespel polyimide, Ultra-High-Molecular-Weight Polyethylene (UHMWPE), Ethylene Propylene Diene Monomer (EPDM), and PEEK (Polyetheretheracetone).

Specific Notes:

- 1) Graphite gasket material may be suitable for much higher pressures and temperatures depending on the specific fluid service (i.e. chemical properties of the service fluid). Consult the ESM Pressure Safety Point-of-Contact for specifics.
- 2) Reinforced Teflon may be suitable for higher pressures and/or lower temperatures depending on the formulation of the Teflon and the reinforcement material used.
- 3) Use of aramid fiber gasketing should be avoided in steam service.
- 4) Metal reinforced Teflon is limited to 392°F.
- 5) PTFE and RTFE shall not be used in High Level Waste Transfer Systems or similar system in which high dose will damage the material and changeout is difficult.

General Guidance - Non-metals

The following is a brief description of some of the common types of seating and packing materials, and their general use.

PTFE

Virgin Teflon polymer. PTFE has good temperature, chemical, and anti-friction properties. It is inert to most chemical attack, but is affected by liquid alkalis, fluorine, and radiation. It can cold flow under high stress. Maximum 1×10^4 RADS lifetime dose. PTFE shall not be used in High Level Waste Transfer Systems.

RTFE

Reinforced Teflon - PTFE reinforced with added fillers, usually fiberglass. The filler provides a higher resistance to cold flow, and allows larger application range. There is a slight increase in friction. Maximum 1×10^4 RADS lifetime dose. RTFE shall not be used in High Level Waste Transfer Systems.

UHMWP

Ultra High Molecular Weight Polyethylene. UHMWP is a thermoplastic polymer with exceptionally high notched impact strength, and resistance to stress cracking and abrasion. It has good resistance to most chemicals, but is not recommended for strong acids and organic solvents. It offers higher resistance to radiation than PTFE. Maximum 2×10^7 RADS lifetime dose.

TEFZEL

TEFZEL fluoropolymer is a thermoplastic in the same family as PTFE, but is more radiation resistant. Maximum 2×10^7 RADS lifetime dose.

PEEK

Polyetheretherketone offers increased steam handling capabilities, and have generally higher the temperature ratings. It has good corrosion resistance, and excellent resistance to radiation. Maximum 1×10^9 RADS lifetime dose.

FEP

A melt-processable PTFE with essentially those same properties.

DELRIN

DELRIN is another polymer that is used at higher pressures, and also has higher resistance to radiation than PTFE. Maximum 1×10^6 RADS lifetime dose.

NITRILE (NBR, BUNA-N)

Used for low aromatic petroleum solvents, fuels and oils, water, air, and inactive gases.

VITON

Used in high aromatic and halogenated solvents and fuels. Also used in low pressure steam and strong mineral acids.

EPDM

Used for resistance to ozone, weathering, and heat. It has poor resistance to oils, hydrocarbons, alcohols, and radiation.

General Guidance - Metals

The following is a brief description of some of the common metals used in valve construction, and their general use.

CAST IRONS

Generally used in low hazard services (e.g. water or oil). Cast irons have a low cost and are readily available. Disadvantages - no weld end valves, generally poor corrosion resistance, and code limitations.

BRONZE

Generally used in low hazard services (e.g. water or oil). Bronze alloys have a low cost and are readily available. They can have better corrosion resistance than Carbon Steel in some water services. Disadvantages - limited welding.

CARBON STEEL

Carbon steels are the standard selection for many services where corrosion resistance is not critical. It has a relatively low cost and is readily available. Disadvantages - generally poor corrosion resistance.

TYPE 304(L)

SS Austenitic stainless steels are used for their high resistance to oxidation and sulfidation, and where general resistance to corrosion is desired. They are also used widely for cryogenic services. Disadvantages - susceptibility to certain specific corrosion processes (e.g. stress corrosion cracking and intergranular corrosion) in certain media. Type 304(L) is generally a special order valve material, and has been replaced as the "standard" stainless steel material with type 316(L).

TYPE 316(L)

SS Austenitic stainless steels are used for their high resistance to oxidation and sulfidation, and where general resistance to corrosion is desired. They are also used widely for cryogenic services. Type 316(L) has a better resistance to attack by reducing agents, and lower susceptibility to pitting than type 304(L). Disadvantages - susceptibility to certain specific corrosion processes (e.g. stress corrosion cracking and intergranular corrosion) in certain media.

ALLOY 20

Alloy 20 was developed to provide resistance to sulfuric acid over a wide range of concentrations and temperatures. It has good corrosion resistance to other media as well, and is widely used for handling caustic soda, organic acids, chlorinated hydrocarbons, sludge acids, etc. Disadvantage -- cost.

MONEL

Monel provides excellent resistance to sea water, and good resistance to aqueous sulfide and caustic. It is resistant to chloride stress corrosion cracking. It is widely used for handling alkalis, salt water, organic intermediates, and many air-free acids. Disadvantages -- poor resistance to sulfidation above 400°F, and embrittled by sulfur and heavy metals at low concentrations during welding or heating. Corroded rapidly by ammonia and compounds.

INCONEL

Inconel is generally used for handling corrosive media at elevated temperatures. It provides good general corrosion and oxidation resistance, good elevated temperature strength, good resistance to chloride stress corrosion cracking, and excellent corrosion resistance to caustic. Disadvantages - poor sulfidation resistance above 1000°F creates working and welding problems, vulnerable to sensitization and intergranular cracking in some services, and cost.

HASTELLOY B/B2

Hastelloy B provides good resistance to reducing atmospheres at elevated temperatures, and is very resistant to stress corrosion cracking. It is also used for handling hydrochloric acid vapor and varied concentrations of hot sulfuric, hydrochloric, and phosphoric acids. Disadvantages - cost, availability, sensitizes, and can be vulnerable to intergranular corrosion in many services.

HASTELLOY C/C276

Hastalloy C provides good resistance to hypo-chlorites and other solutions containing free chlorine in considerable concentrations. It is also used for handling both oxidizing and reducing chemicals, and is very resistant to stress corrosion cracking. Disadvantages—cost,availability.

REF-3 ASME B31.3 Process Piping Guide

APPENDIX D – VALVE SELECTION GUIDE**Introduction**

This Appendix addresses proper selection and specification of manual valves and check valves for use in ASME B31.3 systems. This information may be used for guidance in the selection of valves for use in services covered by other piping codes at the discretion of the cognizant engineer. This Appendix does not give absolute direction for the selection of specific valves for specific services. Final selection of a valve and determination of acceptability must be made by the appropriate engineering organization.

Initial selection of valves for any process or service is an engineering decision. Consideration should be given to the required materials of manufacture (body, seats, stem, packing, etc.), type of valve required, fluid sealing requirements, flow throttling requirements, potential transient concerns, etc. Selection of different types of valves can result in extremely different system response to valve action.

References

- ASME B31.3, Process Piping
- ASME B31.1, Power Piping
- *Lyons' Valve Designer's Handbook*, 1982, by Jerry L. Lyons
- *Valve Selection Handbook*, 2nd edition, by R. W. Zappe

Acronyms and Definitions

The following acronyms and definitions are applicable to this Guide. They may either appear in this Guide, or in various vendor valve catalogs. Understanding of these acronyms and what they mean may be necessary to proper valve selection.

ASME: The American Society of Mechanical Engineers.

API: The American Petroleum Institute.

MSS: The Manufacturers Standardization Society of the Valves and Fittings Industry, Inc.

AWWA: The American Water Works Association

CWP: Cold Working Pressure. Refers to the ambient temperature rating of a valve that is normally understood to be -20°F to 100°F. May also be identified as:

WOG (Water, Oil, Gas pressure)

WO (Water, Oil pressure)

OWG (Oil, Water, Gas pressure)

GLP (Gas, Liquid pressure)

WWP (Working Water Pressure)

W (Water pressure).

These markings are typically applied to Bronze and Iron valves. Refer to the applicable standard governing the manufacture for more details on the pressure rating.

SWP: Steam Working Pressure. Usually the high temperature rating and may relate to the maximum saturation pressure/temperature that the valve is rated for. May also be identified as:

Section REF References

Rev. 0, 9/17/2014

REF-3 ASME B31.3 Process Piping Guide

WSP (Wet Steam Pressure)

SP (Steam Pressure)

S (Steam pressure)

These markings are typically applied to Bronze and Iron valves. Refer to the applicable standard governing the manufacture for more details on the pressure rating.

Class: This refers to the pressure/temperature rating of the valve (e.g. Class 150 which is sometimes incorrectly referred to as 150 lb.) per the applicable standard of manufacture, some of which are identified in Table D-1.

Cv: The flow coefficient sometime identified for valve flow/pressure loss. This value equates to the flow in GPM at 1 psi differential pressure across the valve using 60°F water.

Required National Codes/Standards Conformance

When used in ASME B31.3 systems, valves are required to be manufactured and tested in accordance with listed standards or they must be qualified as “unlisted” components. Other national consensus standards for piping systems have similar requirements. Table D-1 identifies the standards related to valve manufacture that are accepted as “listed” standards for use in ASME B31.3 systems. Valves that do not conform to one of these standards may be used provided that the ASME B31.3 requirements for qualification of unlisted components is met (refer to paragraph 304.7.2 of ASME B31.3).

Table D-1 Standards for Valves

Standard	Title
ASME B16.34	Valves - Flanged, Threaded, and Welding End
API 594	Check Valves: Flanged, Lug, Wafer, and Butt-welding
API 599	Metal Plug Valve – Flanged, Threaded and Welding Ends
API 600	Steel Gate Valves-Flanged and Butt-welding Ends, Bolted Bonnets
API 602	Steel Gate, Globe, and Check Valves for Sizes NPS 4 (DN 100) and Smaller for the Petroleum and Natural Gas Industries
API 603	Corrosion-resistant, Bolted Bonnet Gate Valves—Flanged and Butt-welding Ends
API 608	Metal Ball Valves – Flanged, Threaded, and Welding Ends
API 609	Butterfly Valves: Double-flanged, Lug and Wafer-Type
AWWA C500	Metal-Seated Gate Valves for Water Supply Service
AWWA C504	Rubber Seated Butterfly Valves
MSS SP-42 (Note 1)	Class 150 Corrosion Resistant Gate, Globe, Angle and Check Valves with Flanged and Butt Weld Ends
MSS SP-67 (Note 1)	Butterfly Valves
MSS SP-70	Gray Iron Gate Valves, Flanged and Threaded Ends
MSS SP-71	Gray Iron Swing Check Valves, Flanged and Threaded Ends
MSS SP-72	Ball Valves with Flanged or Butt-Welding Ends for General Service
MSS SP-80	Bronze Gate, Globe, Angle and Check Valves
MSS SP-81	Stainless Steel, or Stainless-Steel Lined, Bonnetless, Knife Gate Valves with Flanged Ends
MSS SP-85	Gray Iron Globe & Angle Valves Flanged and Threaded Ends
MSS SP-88	Diaphragm Valves

Note 1: These valves are acceptable even though not listed in Table 326.1 of ASME B31.3. They are listed in Table 126.1 of ASME B31.1. The additional requirements of ASME B31.1 must be met in that “only valves designed such that the valve stem is retained by an assembly which functions independently of the stem seal retainer shall be used” (refer to paragraph 107.1(D) of ASME B31.1).

REF-3 ASME B31.3 Process Piping Guide

Selection of Valve Type

One of the principal decisions in valve selection is valve type. Selection of the proper valve type should be based on service experience that demonstrates a particular valve type performs well in a particular service. Manufacturers and operating facilities are good sources of information in this respect. Some general guidance for selection of valve type is provided herein, and is available from various reference materials. Table D-2 provides some general service descriptions and the type of valve commonly selected for those services as indicated in Reference Lyons. Table D-3 provides similar information as identified in Reference Zappe. This information should not be viewed as absolute, nor is it intended to exclude certain types of valves from any services. Decisions of this nature are left to the cognizant engineer. Manufacturer's recommendations may be very helpful in this regard as well.

Table D-2 Valve Selection

Service	Description of Service	Recommended Valve
Contamination	Control of fluids which may cause contamination buildup, a valve with minimum obstruction to flow is needed	Ball, Gate, Globe, or Pinch
High Pressure	Control of flow at high pressures - selection of a valve to be used in a high pressure application, particularly pneumatic, should be approached with caution	Ball or Globe, Poppet Valves are occasionally used
High Temperature	Control of flow at high temperatures	Ball or Globe, Poppet Valves are occasionally used
Low Leakage	Control of flow with very low seat leakage in the closed position	Ball, Gate, Globe, or Plug
Shutoff	Normal on-off control	Ball, Gate, Globe, or Plug - Ball and Plug Valves normally operate faster
Steam Service	Control of steam under pressure	Ball or Globe
Throttling	Control the amount of flow by varying the valve position	Globe - Ball and gate valves tend to vibrate under flow, and erosion is a concern when using gate valves

Table D-3 Valve Selection

Valve	Type	Mode of Flow Regulation			Fluid				
		On-Off	Throttling	Diverting	Free of Solid	Solids in Suspension		Sticky	Sanitary
						Non-Abrasive	Abrasive		
Globe	Straight Pattern	Yes	Yes		Yes				
	Angle Pattern	Yes	Yes		Yes	Special	Special		
	Oblique Pattern	Yes	Yes		Yes	Special			
	Multi-Port			Yes	Yes				
	Piston	Yes	Yes		Yes	Yes			
Parallel Gate	Conventional	Yes			Yes				
	Conduit	Yes			Yes	Yes	Yes		
	Knife	Yes	Special		Yes	Yes	Yes		
Wedge Gate	With bottom Cavity	Yes			Yes				
	Without Bottom Cavity (rubber seated)	Yes	Moderate		Yes	Yes			
Plug	Non-lubricated	Yes	Moderate	Yes	Yes	Yes			
	Lubricated	Yes		Yes	Yes	Yes	Yes		Yes
	Eccentric Plug	Yes	Moderate	Yes	Yes	Yes		Yes	
	Lift Plug	Yes		Yes	Yes	Yes		Yes	
Ball	---	Yes	Moderate	Yes	Yes	Yes			
Butterfly	---	Yes	Yes	Special	Yes	Yes			Yes
Pinch	---	Yes	Yes		Yes	Yes	Yes	Yes	Yes
Diaphragm	Weir Type	Yes	Yes		Yes	Yes		Yes	Yes
	Straight Through	Yes	Moderate		Yes	Yes		Yes	Yes

Additional information on some of the more common valve types is provided in the following paragraphs. Typical applications and some common problems that may be helpful in the selection of the proper valve are discussed, as well as a brief description of some common valve types. Other valve types such as pinch valves, and diaphragm valves are less common, and thus not described. However, these types of valves may be selected at the discretion of the cognizant engineer.

Gate Valves

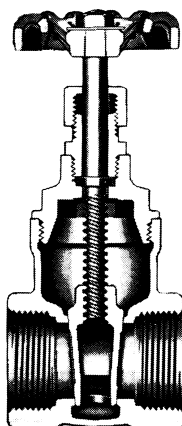

Gate valves are the most common type of valve used in industrial applications. It functions by inserting a disc across the flow path. Gate valves may be used in systems where flow direction varies and can be reversed as this valve type is “bi-directional,” i.e. valve operation and flow characteristics are the same for either direction of flow. Gate valves should be used in the wide open or fully closed position only, as this valve type is usually not suitable for throttling service. Having very little resistance to flow, it is ideal for conditions where the pressure drop is critical.

Some examples of available disc designs for gate valves are shown in the following figure. All of the disc designs are used for the same type services, except that the solid wedge disc designs are not suited for applications with large variations in temperatures. Note that the “double disc” gate valve is sometimes referred to as a “split disc” gate valve.

DISCS (GATE)

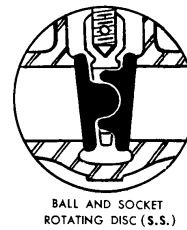
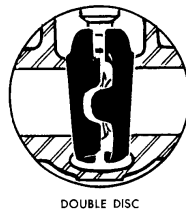
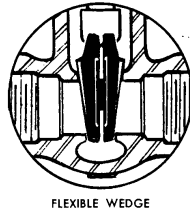
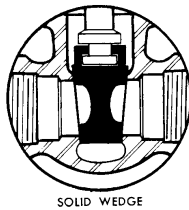

Some of the disadvantages of a gate valve are as follows:

- 1) The full stem travel requires many turns of a handwheel and many more turns when fitted with gearing.
- 2) Due to the long stroke and the outside appurtenances necessary to accommodate this stroke, a longer space envelope (over-all length) is required.
- 3) Body seat surfaces for gate valves are more difficult to machine or refinish.
- 4) Very little or slow movement of the disc near the full closed position causes high velocity flow, resulting in galling of the sliding parts and scoring of the seating surfaces (often called "wire drawing").
- 5) Solid wedge type gate valves have a generic problem called "thermal binding." This condition occurs when a valve is closed tightly while the high temperature system it is located in is still in operation. Subsequently, the system is shut down, and cooldown takes place. Because of the internal design of a wedge gate valve, the seats move inward at an amount greater than the wedge shrinkage occurring during cooldown. The difference in thermal contraction can bind the wedge tight enough so that it cannot be reopened until the system temperature is raised enough to reheat the valve.
- 6) Solid wedge gate valves in systems where severe temperature changes occur are also subject to excessive seat leakage due to changes in angular relationship between the wedge and the seat faces due to pipe loads exerted on the valve ends.
- 7) Metal-seated gate valves should not be used for air or gas service because they do not have the bubble-tight closure necessary for these services.

Globe Valves

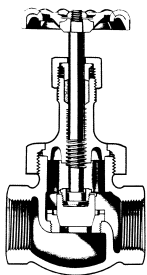

Globe valves are also very commonly used in industrial applications. The globe valve controls flow by lifting or lowering a circular disc on a seat designed to accept the contour of the disc. Globe valves are commonly used as throttling valves as well as stop valves. The throttling capability of the valve is very dependent on the design of the disc. In most cases, discs furnished are of the "quick-opening" or "semi-throttle" designs, which do not provide for very accurate throttling. If additional throttling is required, other disc forms are available on special order, such as the "linear" and "equal percentage" designs, which provide much better throttling characteristics. These characteristics of the valve operation may be important if the valve is required for throttling service. Globe valves can be used in gas applications and provide

Section REF References

Rev. 0, 9/17/2014

REF-3 ASME B31.3 Process Piping Guide

“bubble-tight” closure if the discs are furnished with resilient inserts. Some examples of typical globe valve disc designs are shown in the following figure. Note that the V-Port type Plug Disc is usually intended for fine throttling applications, and the other discs fall into the quick-opening or semi-throttle category.

DISCS (GLOBE)

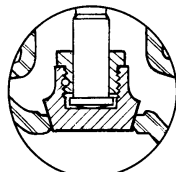

PLUG TYPE DISC

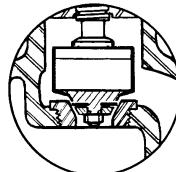
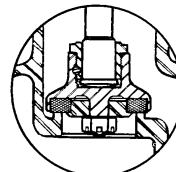

V-PORT TYPE PLUG DISC

DUAL-SEAL WAFER DISC
AND RENEWABLE SEAT

COMPOSITION DISC

The globe valve has historically been used primarily for throttling service. In some cases where system flow can reverse, the globe valve has been used as a stop valve (where the pressure is acting on top of the disc and tending to force the valve closed). Small globe valves

2 inches and smaller may be used as stop valves because the force under the disc is within the capability of the stem threads to keep the valve closed. In throttling service (being partially opened the majority of the time), the valves must be equipped with deep stuffing boxes, and the disc should be guided along full travel.

Additionally, globe valves are used for services requiring frequent operation and positive shutoff.

The maximum differential pressure across the valve should not exceed 20 percent of the upstream line pressure and never exceed 200 psi, unless a special trim and disc design is provided by the manufacturer.

Small globe valves can be used as piping or equipment high point vent or low point drain connections as well as root valves for instrument pressure connections. Globe valves with special trim are used for blowoff or blowdown system applications.

Globe valves are available in various body configurations. Some advantages of these different configurations are:

- 1) Tee Pattern (standard): When severe throttling is required as in a bypass line around a control valve where pressure drop is not a concern. This pattern has the lowest Cv.
- 2) Wye Pattern: When valve is normally wide open and throttling during seasonal or startup operations is required. This valve type has very little resistance to flow and can be “cracked open” for long periods without severe erosion.
- 3) Angle Pattern: Similar in application to the wye pattern globe with a slightly lower Cv. A particularly good selection for systems that have periods of pulsating flow because this valve configuration adequately handles the “slugging” effect inherent with this type of flow.

Butterfly Valves

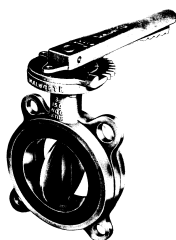

The butterfly valve (also called a trunnion valve) is a quarter turn valve that rotates a disc in the flow stream. These valves were originally intended to be lightweight, non-leaktight seating dampers. Many varieties of this valve are still intended for this “non-leaktight sealing” service, however design improvements in high performance butterfly valves have produced some which are acceptable for high pressure, high temperature service with bubble tight closure.

Butterfly valves are generally used as stop valves for throttling purposes in water systems. In particular large diameter piping systems of ANSI Classes 150 and 300

Section REF References

Rev. 0, 9/17/2014

REF-3 ASME B31.3 Process Piping Guide

with resilient seating materials and much higher class ratings for metal seating materials are poorly suited for stop valve service. Smaller butterfly valves are used in piping arrangements where space limitations dictate their use over dimensionally long valve types.

In addition to the price advantage in the large sizes, the butterfly valve also has a definite weight advantage. The following is a typical weight comparison when using an ANSI Class 150 wafer style butterfly valve:

Butterfly = 53 lbs.

Ball = 158 lbs.

Gate = 310 lbs.

Butterfly valves fall into the category of “flow sensitive valves” because the disc movement is unguided and their operability is affected by incoming turbulence. Close proximity of the butterfly valve to certain piping components can amplify the normal dynamic reactions. For example, the velocity profile of the discharge of a pump is not symmetrical. When installed at the discharge of a centrifugal pump with a vertical shaft, the result can be fluid dynamic torques that are twice the magnitude of those found for a valve with straight run of pipe upstream. The eccentric forces applied to the valve disc produces excessive vibration and “disc flutter” which eventually results in a complete breakdown of the valve.

Butterfly valves may be used for throttling service. However, in throttling applications, the major concern for the valves is cavitation. The recommended range of flow control is between the 30° and 80° disc opening, although throttling operations require individual study. Acceptability of throttling performance may also depend on the location of the valve in a piping run and whether the valve has a free discharge or discharges into a closed system.

Ball Valves

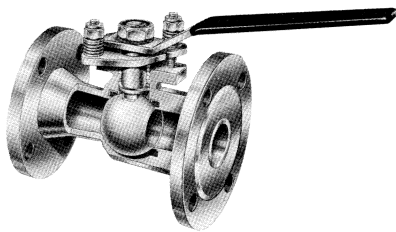

The ball valve is another quarter turn valve, and consists of a highly polished spherical ball with an opening (port) bored through the center. The ball is wedged between two seat rings, which are typically a relatively soft material (Teflon, Viton, EPDM, etc). Valve operation involves rotating the ball to either align the port with the flow stream to open the valve, or aligning the solid portion with the flow stream thereby closing the valve.

All 2-way ball valves furnished with two seat rings are bi-directional; flow entry can be from either end without comprising the function of the valves. However, single seated valves have a “preferred” entry and are therefore classified as “unidirectional.” Another condition that makes a ball valve unidirectional is when the valves are furnished in the 3-way, 4-way, or 5-way designs where flow must enter a designated port in order to divert the flow toward the established direction. Because of the complicated machining process within the ball discs for multiport ball valves, sharper turns are necessary so resistance to flow is a necessary result when compared to the traditional 2-way valve.

Ball valves are used as bubble-tight stop valves for relatively clean fluid systems, such as air, water, and gas. The popularity of this valve is enhanced by its very small space envelope for a given line size and its quarter turn operation from the closed to open position.

The multiport ball valve is used frequently for diverting flows to several directions using a single valve. In addition, the valve (manually actuated) has a very low center of gravity and is constructed of a very simplified design. With its few moving, and accessible parts, this valve design rates very high with respect to maintenance costs. The temperature limitations for the various seat and seal materials give a wide range of service temperature conditions that can be accommodated. Standard ball valves should

REF-3 ASME B31.3 Process Piping Guide

not be used for any sustained throttling (over 2 hours at a maximum differential pressure of 50 psi) as severe erosion of the ball and seat ring may result. However, several manufacturers have specific ball valve designs that are intended for throttling service.

The ball valve has a generic design problem that exists when suspended solid particles in the fluid system (resins, oxide particles, etc.) settle-out and become trapped in the cavities below the ball and in the vicinity of the stem or trunnion areas. This occurs typically when flow has stopped and this “crud” has had time to become encrusted. One solution to this problem is to position all valves mounted in a horizontal run of pipe so that the stems or turnings are on the horizontal. This valve position will promote the “self-scouring” motion when flow returns.

Multiport ball valves can provide the function of two or more valves when used in systems where flows are frequently diverted to various directions. The flow inlet and outlet ports designated by the manufacturer should not be altered to avoid “by-passing” between ports.

Plug Valves

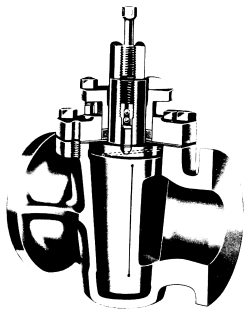

The plug valve is very similar to the ball valve except that instead of a ball with a port, a cylindrical plug with an elliptical or round port is used. Plug valves are used as bubble-tight, on-off stop valves in a variety of fluid systems, including air, gas, oil or oil mixtures, and liquid slurries.

Due to the fact that the plug sealing methods do not promote “crud traps” or internal pockets where deposits could accumulate, plug valves have functioned successfully with dust, dirt, or other gritty contaminants suspended in the above systems.

The unique quality of this valve, to be “self cleaning” by automatically “wiping off” accumulated deposits in the closed position as the plug is rotated, makes

this valve highly recommendable for contaminated systems.

Plug sealing is accomplished using one of two methods: (1) a sealant forced into machined passages around the valve ports, and (2) a resilient liner or sleeve into which the machined tapered plug is forced. The sealant also acts as a lubricant and can typically be used in systems whose service temperature is as high as 650 F. The resilient material (usually an elastomer) is limited by the temperature rating of the sleeve material. In systems such a demineralized water, where conductivity is monitored and should not be exposed to contaminants, the lubricated plug valve should not be used.

Throttling service should not be the primary function of a plug valve. However, if throttling accuracy is not important, non-lubricated plug valves may be used if the valve is equipped with a device to hold the plug to a “set” position and prevent “drifting” to the closed position. Lubricated plug valves should not be used for throttling because the sealant grooves adjacent to the port opening would be exposed to the flow stream and a considerable amount of sealant would be “washed away” by the system fluid velocity. Cylindrical plug valves, particularly those with round ports, are not produced by many manufacturers so the justification for selection of this type of valve must be based upon specific system requirements.

Check Valves

The check valve operates automatically to pass flow in one direction, and prevent any reversal of flow. The valves typically give no indication of setting, or warning of its condition. These valves are also referred to as non-return valves, and are not usually intended to provide a tight shutoff function. There are numerous check valves types and configurations. Some of the more common types include: the swing check, the lift check, the tilting disc check, the folding disc check, and the stop check. Different services may require different types of check valves. It is important to consider the required velocity to

REF-3 ASME B31.3 Process Piping Guide

fully open the check valve, closure time on flow reversal, and other operating characteristics when selecting a check valve. Much of this information is specific to a particular valve and is available only from the manufacturer.

5.6.1 SWING CHECK

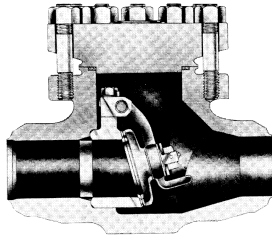

The swing check valve is widely used because most system flow conditions (velocity and pressure) are within the acceptable range recommended for this valve. Body configurations are available in Tee, inclined or Wye, and wafer styles. The majority of these valves have “swings” or hinges near the top of the valves or near the access point. Swing check valves typically (except for wafer types) have top access to the valve internals for replacement of parts or seat refinishing.

Seat materials vary for swing check valves and are dependent on service requirements. Seating may be metal-to-metal or metal to resilient material, and may be either integral or replaceable. Seating angles vary from 0° to 45° and serve two purposes:

- 1) The length of disc travel is reduced with a higher seat angle. Thus, the danger of water hammer may also be reduced with a quicker closing disc.

372

When swing check valves with a vertical seat (0° angle) are located in horizontal runs of piping, slight slopes may cause the valve to hang open. A seat angle of 5° to 7° can typically correct for this.

The seating surfaces have a broad contact area due to the problem of seat alignment. The swing disc is unguided along its full travel and depends on a hinged action that must maintain relatively loose tolerances to accomplish, at best, a fair leak tight seating. The looseness provided at the disc connection to its holder or pivot arm allows the disc to rotate under turbulent flow. This rotation has contributed to some cases of discs separating from their holders. The engineer may need to place special emphasis on the disc connection details of the holder and method of fastening.

It is important that the service conditions ensure the disc remains in its full open position to prevent disc flutter that can damage the valve. Swing check valves have a tendency to “slam” shut on flow reversal. This shortens the life and leak tightness of the seating surfaces. Some manufacturers offer options such as an outside lever to control the travel time of the disc.

LIFT CHECK

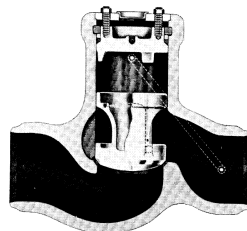

The lift check is another widely used check valve. It is more versatile than the swing check in that some designs will adapt to pulsating flows and, in general, can be used in higher velocity systems. The seating arrangement is similar to that of the globe valve with fully guided disc travel and point contact seating surface interface, which results in better leak tightness than the swing check.

Body configurations are similar to those of globe valves with similar loss characteristics. Lift check discs are available in the form of a piston (or poppet) and a ball. The ball lift check is typically used for highly viscous fluids where low velocities do not cause excessive ball rotation.

TILTING DISC CHECK

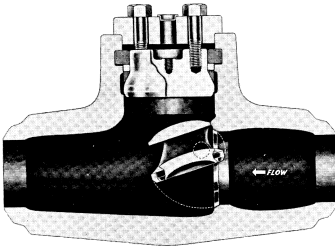

The tilting disc check valve was intended to provide a compromise between the swing check and the lift check. The main features of this valve are a reduction in the slamming effect of the disc on flow reversal and a very short length of travel that results in a quick closing valve.

This type of check valve typically provides access to the internals for maintenance.

FOLDING DISC CHECK

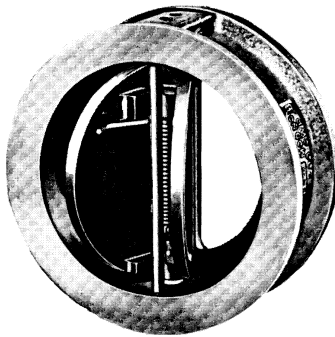

The folding disc check valve (also referred to as the split disc check) utilizes a disc that folds in the middle of the flow stream to permit flow. This type of check valve is used for its space savings features and its quick closing capability. These valves are available from a relatively limited number of manufacturers compared to other types of check valves. It can be mounted in almost any position because it uses a positive force (typically a spring) to provide the closing force.

These valves have many seating material options both in the resilient type or metal to metal type, and are manufactured for various services including air or gas. One good feature of the folding check valve is that there are no internal fasteners to become loosened and cause a breakdown in the valve function.

STOP CHECK

The stop check valve combines the normal free operating functions of a check valve, with the additional capability of providing a temporary stop valve function. To accomplish this they are fitted with a screw-down stem that is not fastened to the disc, but can hold the disc in the closed position. These valves are manufactured either as swing checks or piston lift checks.

These valves must be furnished with a bonnet to contain the stuffing box necessary to provide a dynamic seal around the stem. This necessitates additional material considerations for stem, packing, etc.

Materials

Selection of the proper materials to resist degradation to the desired service conditions is crucial in the selection of the proper valve. This can be a very simple decision for services such as low pressure/temperature air and water, or a very difficult decision for more severe services such as radioactive wastes and hazardous chemical solutions. Resistance of various metals, elastomers, and packing materials to chemical attack can be found in various valve manufacturer catalogs and material handbooks. Some guidance for selection of valves for common fluid services is also provided in Appendix B. See Appendix C for additional discussion on materials selection.

Procurement Level

A graded approach to valve procurement is the responsibility of the cognizant engineering organization based upon the service requirements, level of quality assurance required, and the functional classification of the service. Where specific materials are not crucial to the service, and the service is

REF-3 ASME B31.3 Process Piping Guide

not safety related, lower levels of quality assurance may be acceptable. Where specific materials are required for the correct functioning of the system, quality control checks at receipt inspection should be considered as a minimum. It should also be noted that, for ASME B31.3 systems, material verification in accordance with ASME B31.3 is required (at the percentages noted in that code), and procurement requirements or receipt inspection has no relation to this requirement.

Valve Specifications

The valve style numbering system provided below was developed to provide the cognizant engineer with a convenient method of identifying the desired features in valve procurements. The style number system provides a method of alpha-numeric identification of valves and should be used for identifying valves on the design drawings and/or Bills of Material. This system should be used in addition to the unique component numbering system required by ESM Chapter 1, Section 230, Component Nomenclature.

The following page provides a description of the numbering scheme for the valve specifications. The following **general notes** are applicable to all of the valve specifications:

- 1) Desired features that are required by the engineering design but not identified in the style valve number must be noted in the procurement documents and on the applicable design drawings
- 2) Not all possible combinations of materials are necessarily available. Some combinations may require extensive lead times and high cost. The purchaser should take care to specify only what is required by design, and should consult available manufacturers to decide between acceptable options on the basis of what may be readily available.
- 3) Acceptance of valves that do not specifically conform to all requirements of one of the listed standards (Table D-1) is at the discretion of the cognizant engineer, and may require additional qualification to comply with the applicable piping code (e.g. qualification as an unlisted component per ASME B31.3).
- 4) Valve materials identified are those that are commonly available. Other materials may be available, and material availability changes over time with the advent of new and better materials. The valve style numbering system is controlled by the ESM Pressure Safety Point-of-Contact, and consideration will be given to any additions required by specific facilities on a case by case basis.
- 5) For austenitic stainless steel valves with welded ends (socket weld or butt weld), the low carbon alloys are required (e.g. F304L, CF3, F316L, or CF3M).

Section REF References

Rev. 0, 9/17/2014

REF-3 ASME B31.3 Process Piping Guide

NOTES:		EXAMPLE VALVE STYLE NUMBER: CV 1 0 1 GW - # - A B C D E		
1-ASTM A216 WCB or A105 2-CF3, CF8, F304, or F304L 3-CF3M, CF8M, F316, or F316L 4-Use only in copper piping systems. 5-Includes Swagelok and Parker tube fittings. 6-Includes NBR and Buna-N. 7-Use only non-asbestos. 8-Non welded end stainless steel valves pressure rating is based on the high carbon (non L) grade. 9-Specify port requirement.		1 2 3 4 5 6 7 8 9 10 11 1-Acceptable Standards - LANL Valve 2- Basic Material (Body Material) 3-Pressure Class 4-Type of End Connection 5-Type of Valve 6-Valve Size 7-Disc or Ball Material (optional) 8-Seat Material (optional) 9-Stem Material (optional) 10-Packing Material (optional) 11-Body Gasket Material (optional)		
REQUIRED SPECIFICATION FEATURES				
1) Acceptable Standards	2) Basic Material	3) Pressure Class (8)	4) End Connection	5) Type of Valve
CV Code Valve	1 Brass	0 125	1 Flanged	BL Ball
NV Non Code Valve	2 Bronze	1 150	2 Socket Weld	BT Butterfly
	3 Iron (Cast/Ductile)	2 200	3 Butt Weld	CB Ball Check
	4 Carbon Steel (1)	3 300	4 Threaded	CF Folding Disc Check
	5 Stainless Steel 304/304L (2)	4 400	5 Wafer	CL Tilting Disc Check
	6 Stainless Steel 316/316L (3)	6 600	6 Solder (4)	CP Poppet Check
	7 Monel	8 800	7 Flare	CS Swing Check
	8 Alloy 20	9 900	8 Mechanical	CT Tilting Disc Check
	9 Hastelloy	P Pressure Rated	9 Compression (5)	DV Diaphragm
	E Engineered Procurement		E Engineered Procurement	GF Gate:Flex./Wedge/Split Disc
				GK Knife Gate
				GP Parallel Gate
				GW Solid Wedge Gate
				PI Pinch
				PV Plug
				SC Stop Check
				TA Angle Globe
				TN Needle Globe
				TS Standard Globe
				TY Y Pattern Globe
				V3 Three Way (9)
OPTIONAL SPECIFICATION FEATURES				
7) Disc Material	8) Seat Material	9) Stem Material	10) Packing Material	11) Body Gasket
A Chromium (11-13%)	A Chromium (11-13%)	A Chromium (11-13%)	A Graphite	A Graphite
B Stellite (Hard Face)	B Stellite (Hard Face)	B Carbon Steel	B Teflon	B Teflon
C Bronze	C Bronze	C Bronze	C Natural Rubber	C Natural Rubber
D Stainless Steel	D Stainless Steel	D Stainless Steel	D Nylon	D Nylon
E Monel	E Monel	F Alloy 20	E Nitrile (6)	E Nitrile (6)
F Alloy 20	F Alloy 20	G Hastelloy	F Neoprene	F Neoprene
G Hastelloy	G Hastelloy	H Brass	G Viton	G Viton
H Brass	H Brass	I Nickel Copper	H EPDM	H EPDM
I Nickel Copper	I Nickel Copper	S Special (Specify)	R UHMWPE	I Ferrous
J Teflon	J Teflon	X No Specific Requirement (7)	S Special (Specify)	J Non-Ferrous
K Natural Rubber	K Natural Rubber		X No Specific Requirement (7)	K Spiral Wound w/Teflon
L Nylon	L Nylon			L Spiral Wound w/Graphite
M Nitrile (6)	M Nitrile (6)			R UHMWPE
N Neoprene	N Neoprene			S Special (Specify)

REF-3 ASME B31.3 Process Piping Guide

O Viton	O Viton	X No Specific Requirement (7)
P EPDM	P EPDM	
Q Vespel	Q Vespel	
S Special (Specify)	R UHMWPE	
X No Specific Requirement (7)	S Special (Specify)	
	X No Specific Requirement (7)	

Replacement of Existing Valves

It is important to remember selection of the proper valve for a particular service is an engineering decision, and replacement of existing valves should be with a new valve that has all of the features required by the design. If the specific features that the cognizant engineer originally required are not known, replacement should be in kind unless the valve did not perform satisfactorily.

Replacement of a valve that did not perform acceptably in a given service is the responsibility of the cognizant engineer. The cause of the unsuitability of the valve (e.g. material compatibility, functional problem, etc.) should be determined before a replacement valve is specified.

APPENDIX E – FLANGED CONNECTIONS

Introduction

The guidance provided by this appendix is based on ASME B16.5 flanges. The majority of this guidance is representative of “good practices” that applies to the installation of many types of pipe flanges. Torque values presented herein are based on ASME B16.5 flanges and should be confirmed by engineering prior to use with other flanges.

Many factors can affect the ability of a flanged joint to establish an initial seal and maintain that seal during service for an extended period of time. One of the most important considerations is proper flange installation. The following guidance is provided to ensure that flanges are installed correctly either during initial installation or during maintenance activities.

ASME B31.3 recognizes a variety of national flange standards as “listed” components, including the following:

ASME 16.1 “*Grau Iron Pipe Flanges and Flanged Fittings, Classes 25, 125, and 250*”

ASME 16.5 “*Pipe Flanges and Flanged Fittings,*”

ASME B16.36 “*Orifice Flanges,*”

ASME B16.42 “*Ductile Iron Pipe Flanges and Flanged Fittings, Classes 150 and 300,*”

ASME B16.47 “*Large Diameter Steel Flanges, NPS 26 Through NPS 60,*”

AWWA C207 “*Steel Pipe Flange for Waterworks Service,*”

MSS SP-44 “*Steel Pipeline Flanges,*” and

MSS SP-51 “*Class 150LW Corrosion Resistant Flanges and Cast Flanged Fittings.*”

Pre-Assembly

Prior to assembly ensure that the following actions are completed.

- 1) Fastener materials shall be free of nicks, burrs, chips, dirt, and damage (inspect threads, shank, and nuts). All damaged fasteners must be replaced.
- 2) Flange faces (both raised and flat) must also be clean and free of debris or foreign material. Imperfections such as nicks, dents or gouges will affect the gasket’s ability to seal. The following table may be used to determine the allowable size of imperfections for ASME B16.5 flanges. Multiple imperfections must be separated by at least four times the permissible radial projection, and no protrusions above the serrations are permitted. For smooth flange faces, the right hand column values should be used. The applicability of this criteria to other types of flanges should be evaluated on a case by case basis.

TABLE 1 - Permissible Imperfections

NPS	Maximum Radial Projection of Imperfections Which are No Deeper Than the Bottom of the Serrations	Maximum Depth and Radial Projection of Imperfections Which Are Deeper Than the Bottom of the Serrations
½ ” through 2 ½ ”	0.12”	0.06”
3”	0.18”	0.06”
4” through 6”	0.25”	0.12”
8” through 14”	0.31”	0.18”
16”	0.38”	0.18”
18” through 24”	0.50”	0.25”

Section REF References

Rev. 0, 9/17/2014

REF-3 ASME B31.3 Process Piping Guide

- 3) Gaskets used in ASME B16.5 flanges must satisfy the requirements of ASME B16.20a for metallic gaskets and ASME B16.21 for non-metallic flat gaskets. Gaskets used in ASME B16.1 flanges must comply with ASME B16.21. Table 2 provides groups different gasket types to be used for the selection of torque values. Refer to Appendix C for guidance with materials selection.

Table 2 - Gaskets

Group I ⁽¹⁾	Group II	Group III
Nitrile, Neoprene, Viton, EPDM	Reinforced Teflon, Graphite, NBR/Synthetic Fiber, SBR, NBR, or EPDM /aramid Fiber, Spiral Wound - low stress	Spiral Wound w/ any filler material (e.g., Flexitallic style CG)

Notes: 1. Group I gaskets should only be used with flat face flanges.

- 4) With flat sheet non-metallic gaskets, thinner gaskets are preferred (typically 1/16").
- 5) Ensure that gaskets are of the correct material and size. Gaskets must be clean and not bent, broken, torn or distorted in any manner. The allowable shelf life must be checked.
- 6) No more than one gasket shall be used between contact faces in assembling a flanged joint.
- 7) Flange surface finish (roughness) should be compatible with the gasket material. Soft gaskets such as neoprene should have a rough finish (e.g., 250AA) and flat metal gaskets should have a smoother finish (e.g., 32AA). The typical finish provided on B16.5 flanges (i.e., 125µin to 500µin) is normally acceptable for use with gaskets listed in Table 2
- 8) Use only calibrated torque wrenches and multipliers. Examine the torque wrench for proper calibration, damage, and proper range. Torque wrenches can be used only within the range specified by the wrench manufacturer. Specified working ranges typically vary from 25% - 75% to 20% - 100% of the full torque wrench range.
- 9) Appropriate calculations must be made when using multipliers, a crows foot, or any other attachment which adds length to the torque wrench (cheater bars are not acceptable).

Assembly

The following instructions provide guidance for proper assemble or re-assembly of a flanged connection.

- 1) Prior to bolting up, flange faces shall be aligned properly. Ideally, the flange faces should be parallel to within 1/16 in/ft (0.5%) measured across any diameter and the bolt holes shall be aligned within 1/8" maximum offset (ref. Figure 1). Table 3 presents the required alignment for Class 150, 300, and 600 Flanges. The values for Class 600 flanges may be applied to high classes of steel flanges as well.

Table 3 - B31.3 Required Alignment for Class 150 Flanges

Pipe Size (in.)	Allowable Gap (in.)		
	Class 150	Class 300	Class 600
½	0.018	0.020	0.020
¾	0.020	0.024	0.024
1	0.022	0.025	0.025
1 ½	0.026	0.032	0.032
2	0.031	0.034	0.034
3	0.039	0.043	0.043
4	0.049	0.052	0.056
6	0.057	0.065	0.073
8	0.070	0.078	0.086
10	0.083	0.091	0.104

Pipe Size (in.)	Allowable Gap (in.)		
	Class 150	Class 300	Class 600
12	0.099	0.107	0.115

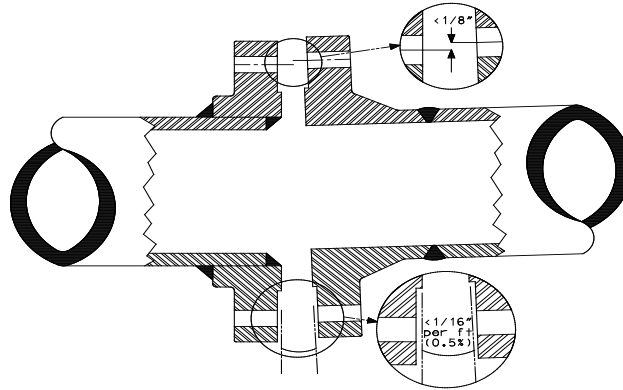

Figure 1 - Flange Alignment Requirements per ASME B31.3

- 2) The proper lubricant shall be used on threads of bolts and nuts. Use low or no chloride content lubricants with stainless steel (e.g., Fel-Pro C-100 Antiseize Compound).
- 3) Use hardened steel washers and/or lubricate smooth face of nut (i.e., face under compression load). Raised lettering on the nuts must be faced outward.
- 4) All nuts must be snug tight prior to torquing.
- 5) Torque values are a function of both the gasket and fastener materials as well as the size and class of flange. Application of the torque values listed in Table 4 ensure that gaskets receive the proper pre-load stress. These torque values are sufficient to seat the listed gasket materials. When significant external mechanical or thermal loads are imposed on a flanged joint, additional evaluation by engineering may be required.

TABLE 4 - RECOMMENDED TORQUE VALUES (ft-lbs)

NPS	GROUP I		GROUP II		GROUP III	
	Torque Class 150 FLAT FACE ^(1,2)	Torque Class 150 RAISED FACE	Torque Class 300 RAISED FACE	Torque Class 300 RAISED FACE	Torque Class 600 RAISED FACE	Torque Class 600 RAISED FACE
1/2"	10	20	20	20	65 ⁽³⁾	65 ⁽³⁾
3/4"	12	22	28	35	130 ⁽³⁾	130 ⁽³⁾
1"	14	26	40 ⁽³⁾	45	130 ⁽³⁾	130 ⁽³⁾
1 1/2"	20	35 ⁽³⁾	50 ⁽³⁾	115 ⁽⁴⁾	225 ⁽³⁾	225 ⁽³⁾
2"	35	60	100 ⁽³⁾	75 ⁽³⁾	130 ⁽³⁾	130 ⁽³⁾
2 1/2"	45	85 ⁽³⁾	100 ⁽³⁾	105 ⁽⁴⁾	225 ⁽³⁾	225 ⁽³⁾
3"	50	90 ⁽³⁾	100 ⁽³⁾	135 ⁽³⁾	225 ⁽³⁾	225 ⁽³⁾
4"	35	60 ⁽⁴⁾	100 ⁽³⁾	190 ⁽³⁾	225 ⁽³⁾	365 ⁽³⁾
6"	50	95	170 ⁽³⁾	190 ⁽³⁾	225 ⁽³⁾	550 ⁽³⁾
8"	70	130 ⁽³⁾	170 ⁽³⁾	305 ⁽³⁾	365 ⁽³⁾	775 ⁽⁵⁾
10"	75	135	275 ⁽³⁾	330 ⁽³⁾	550 ⁽³⁾	1090 ⁽⁵⁾
12"	105	190 ⁽⁴⁾	275 ⁽³⁾	490 ⁽³⁾	775 ⁽⁵⁾	1190 ⁽⁵⁾
14"	145	265 ⁽⁴⁾	410 ⁽³⁾	500 ⁽³⁾	775 ⁽⁵⁾	1430 ⁽⁵⁾
16"	130	240	410 ⁽³⁾	700 ⁽³⁾	1090 ⁽⁵⁾	1900 ⁽⁵⁾
18"	150	275	585 ⁽³⁾	685 ⁽³⁾	1090 ⁽⁵⁾	2735 ⁽⁵⁾
20"	140	260	585 ⁽³⁾	755 ⁽³⁾	1090 ⁽⁵⁾	2735 ⁽⁵⁾
24"	195	365	820 ⁽³⁾	1165 ⁽³⁾	1900 ⁽⁵⁾	4260 ⁽⁵⁾

Specific Notes:

Section REF References

Rev. 0, 9/17/2014

REF-3 ASME B31.3 Process Piping Guide

1) Left column torque values are based on a gasket hardness of Type A Shore durometer < 50. Right column torque values are based on Type A Shore durometer ≥ 50 . 2) Not recommended for fluid services that exceed 125 psig. 3) Do not use A193 B8 Class 1 or A307 fasteners. 4) Do not use A193 B8 Class 1 fasteners. 5) Use only A193 B7 fasteners.

Section REF References

Rev. 0, 9/17/2014

REF-3 ASME B31.3 Process Piping Guide

General Notes:

- Table is based on ASME 16.5 flanges with properly sized bolts.
- Torque tolerances:
 - ± 2 ft-lbs if torque value is ≤ 50 ft-lbs
 - ± 4 ft-lbs if torque value is ≤ 100 ft-lbs
 - ± 4% of torque value if > 100 ft-lbs.
- For sheet gaskets, torque values can be used for 1/32" through 1/8" thick gaskets.
- Contact engineering for assistance with torque values outside the scope of this table.

6) Table 5 provides the maximum allowable torque values for common bolt materials. These torque values shall not be exceeded. Note that some of these bolt materials are not acceptable for the torque values listed in Table 4. The torque values listed in Table 5 result in a preload stress of 90% of the ASME B31.3 Specified Minimum Yield Strength.

Table 5 - Maximum Allowable Torque Values

Bolt Size	Torque (ft lbs.)				Bolt Size	Torque (ft lbs.)			
	A307	B8 cl.1	B8 cl.2	B7		A307	B8 cl.1	B8 cl.2	B7
1/2	34	29	95	100	1/4	585	490	1060	1715
5/8	69	57	190	200	13/8	770	640	1070	2250
3/4	120	100	335	355	1 1/2	1020	850	1420	2985
7/8	195	160	435	570	15/8	1475	1230	-	4305
1	295	245	650	855	13/4	1615	1345	-	4710
1 1/8	415	345	750	1215	17/8	2300	1915	-	6710

7) Table 6 identified acceptable substitute bolt materials for those identified in Table 4. The maximum allowable torque values for the original material are applicable to the substitute material as well.

Table 6 - Acceptable Substitute Bolt Materials

Material	Substitutes		
A193 B8 Class 1	A193 B8T Class 1 A320 B8 Class 1 A320 B8M Class 1 Note: Use Type 6 or 6F Nuts	A193 B8C Class 1 A320 B8T Class 1	A193 B8M Class 1 A320 B8C Class 1
A193 B8 Class 2	A193 B8T Class 2 A320 B8 Class 2 Note: Use Type 8, 8C, 8M, 8T, 8F, 8N, 8P Nuts	A193 B8C Class 2 A320 B8T Class 2	A320 B8C Class 2

- 8) Other, more accurate, methods of obtaining preload such as bolt tensioners or measurement of bolt elongation may be substituted for torque wrenches if performed in accordance with an approved procedure.
- 9) Preload of elastomeric gaskets used with other types of flat faced flanges (fiberglass, aluminum, etc.) should be based on an acceptable leak test. In general 20% - 25% compressive deflection of the gasket will place the material in its most favorable sealing condition.
- 10) The pattern in which bolts are tightened is extremely important. If performed improperly, tightening can cause the flange to move out of parallel. A staggered crisscross-torquing pattern, shown in the following sketch, must be used to tighten the bolts. No more than one third of the final torque should be achieved during a single step.

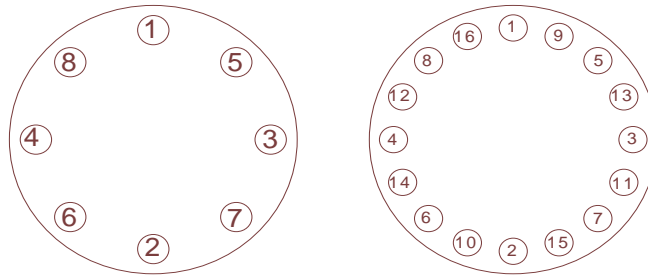

Figure 2 - Typical Torquing Sequences

- 11) Following the first torquing pass confirm that the flanges are parallel. If flanges are not parallel at this point, make two complete passes around the flange at 1/3 of the specified final torque to equalize load in the fasteners and examine again for parallelism. If the flanges are not parallel and full face contact has not been achieved, engineering must evaluate for excessive misalignment.
- 12) The following table is based on ASME/ANSI B16.5 and provides fastener information for commonly used flange classes.

TABLE 7 - Flange Fasteners

NPS	Class 150		Class 300		Class 600	
	Bolts ⁽¹⁾	Size	Bolts ⁽¹⁾	Size	Bolts ⁽¹⁾	Size
1/2"	4	1/2"	4	1/2"	4	1/2"
3/4"	4	1/2"	4	5/8"	4	5/8"
1"	4	1/2"	4	5/8"	4	5/8"
1 1/2"	4	1/2"	4	3/4"	4	3/4"
2"	4	5/8"	8	5/8"	8	5/8"
2 1/2"	4	5/8"	8	3/4"	8	3/4"
3"	4	5/8"	8	3/4"	8	3/4"
4"	8	5/8"	8	3/4"	8	7/8"
6"	8	3/4"	12	3/4"	12	1"
8"	8	3/4"	12	7/8"	12	1 1/8"
10"	12	7/8"	16	1"	16	1 1/4"
12"	12	7/8"	16	1 1/8"	20	1 1/4"
14"	12	1"	20	1 1/8"	20	1 3/8"
16"	16	1"	20	1 1/4"	20	1 1/2"
18"	16	1 1/8"	24	1 1/4"	20	1 5/8"
20"	20	1 1/8"	24	1 1/4"	24	1 5/8"
24"	20	1 1/4"	24	1 1/2"	24	1 7/8"

Notes: 1. Bolts refer to all types of threaded fasteners used in flange joint assembly (ref. section 6.0).

- 13) When sequential torquing is complete, use rotational and reverse rotational tightening to check that all nuts are stable. Nuts are stable when the torque wrench does not turn before the wrench achieves the final bolt torque value.
- 14) Nuts shall have full thread engagement on the bolts or studs. One to two exposed threads is the preferable requirement that defines full thread engagement. The minimum acceptable engagement is the outer edge of the nut being not less than flush with the end of the bolt or stud.
- 15) After leak test and system startup, thermal expansion, creep relaxation and fastener thread embedment can change the fasteners' applied load. Therefore, a re-check of each fastener is

Section REF References

Rev. 0, 9/17/2014

REF-3 ASME B31.3 Process Piping Guide

recommended especially for piping systems that have non-metallic gaskets and operate at temperature levels above 200°F.

Disassembly

Prior to disassembly match mark the flange rim (if appropriate) to ensure that the flanges are reinstalled in their original configuration. Ensure that the following tasks are performed following disassembly:

- 1) Adequate controls are in place to maintain cleanliness.
- 2) Proper cleaning materials are used to clean the flange face and bolting materials.
- 3) Ensure that precautions are taken to prevent sealing surfaces from being damaged.

Trouble Shooting

If a gasket assembly leaks, certain attributes can be inspected in the removed gasket that may help identify the cause of failure. The following examinations should be performed.

- 1) Examine the gasket to determine if it was damaged during installation (e.g., a roll over at the edge of the seating surface).
- 2) Check for chemical attack and over/under compression.
- 3) Check for application of an anti-stick or anti-seize compound. These materials can lower the performance of the gasket.
- 4) Examine the gasket seating surfaces for indications of proper compression and flange face finish.
- 5) Measure the thickness of the gasket material around the circumference of the seating surface. Compression of the gasket more towards the OD of the seating area than the ID is an indication that flange rotation has occurred due to over torquing or excessive mechanical loads.
- 6) Leaking flanges may be tightened an additional 10% above the recommended values in Table 4 provided that the torque does not exceed the maximum allowable value listed in Table 5.

Threaded Fasteners

Threaded fasteners used in flange joints are typically of three different structural shapes; double ended studs, heavy hex bolts, and heavy hex screws.

Studs used in flanges are made from rod and typically are threaded on both ends. The shape of the most common type used in flanges, the double-ended stud, is shown in the following sketch. This type of stud has an unthreaded portion in the middle with ends that are either rounded or flat and chamfered.



Heavy hex bolts are externally threaded fasteners designed for insertion through holes in assembled parts, and are normally tightened or released by torquing a nut.

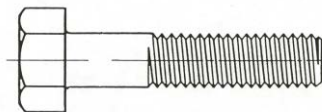

Section REF References

Rev. 0, 9/17/2014

REF-3 ASME B31.3 Process Piping Guide

Heavy hex screws are externally threaded fasteners designed for insertion into holes in assembled parts or mating with preformed internal threads and are normally tightened by torquing the head. The primary difference between a hex bolt and a hex screw is the washer face shown in the following sketch.

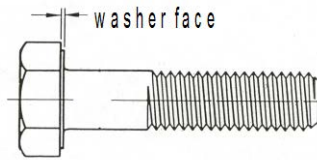

Heavy hex screws and heavy hex bolts that comply with ASME B18.2.1 are interchangeable regardless of the material specification (e.g., ASTM A307). In some sizes, fastener manufacturers opt to produce only heavy hex screws in lieu of heavy hex bolts due to the interchangeability and greater range of application.

When zinc coating is required, all components of mating fasteners (e.g., bolts, nuts, and washers) shall be coated by the same zinc-coating process.

APPENDIX F – ALIGNMENT FIT-UP TOLERANCES

This Appendix provides guidance on ASME B31.3 Code paragraph 335.1.1 “Alignment.” Specifically two sections of the Code are addressed 335.1.1(a) Piping Distortions and 335.1.1(c) Flanged Joints. The data in this Appendix is applicable to either initial installation of the piping system or when performing routine maintenance activities.

PIPING DISTORTIONS

The Code defines piping distortions as any distortion of piping to bring it into alignment for joint assembly that introduces a detrimental strain in equipment or piping components. The Code does not provide criteria on how to evaluate detrimental strain. A limited degree of strain is acceptable for overcoming misalignment at the final closure points in the erection of piping. The amount of misalignment a pipe joint can tolerate is based upon the degree of inherent flexibility available in that system. The degree of acceptable misalignment may be considered as an alignment tolerance.

The methodology applied in Tables 1 and 2 is limited to, three directions of misalignment or displacement misfit at a closure point. The three directions of misalignments are the two axial or lateral directions and face-to-face misalignment. Axial or lateral misalignment is the degree of centerline offset between adjoining sections. Face-to-face misalignment is the amount of separation between adjoining sections that are parallel. In all cases, the two weld-ends at the closure must be parallel within weld fit-up tolerance after cold-pulling. Where this does not occur, one or both weld-ends must be re-beveled for an acceptable fit-up.

The data provided in Table 1 and 2 below should be used as acceptable tolerances on closure fit-up in Code piping systems. Pipe closures made by butt welds, socket welds, and flanged are acceptable when applying the data in Tables 1 and 2.

Table 1 applies only to “strain sensitive” piping systems; those piping systems connected to rotating machinery such as pumps, small turbines, compressors, and unanalyzed vessel and tank nozzles.

Table 2 applies to the non-strain sensitive closures in piping systems.

The lengths of piping tabulated are the minimum total lengths of pipe required which must lie in a direction perpendicular to the direction of a single degree of misalignment to safely permit cold pulling the pipe to close. The example below demonstrates the use of the tables.

Where more than one final closure point occurs in the same system (e.g. between equipment nozzles or full anchor or any combination of these) the misfits at a single point cannot be evaluated independently. No attempt should be made to evaluate and close such a misfit until fit-up conditions are determined in the balance of the system.

When the field misalignments exceed of the values provided in Tables 1 and 2, the piping shall be reworked or evaluated by engineering.

Notes For Tables 1 and 2:

- 1) The length of piping available for the evaluation of a misfit variation in a particular direction is the sum of the piping leg lengths perpendicular to the direction of the misfit variation, only.
- 2) Values of the variations and the required pipe lengths for the variations may be interpolated in the table.
- 3) The tables provide the minimum piping length in units of feet required to accommodate a misfit error in any direction.

TABLE 1 - Pipe Fit-Up Allowances Tolerance For Strain Sensitive Piping

NPS (inches)	Misfit Variation In Any Directions (inches)														
	0.10	0.20	0.30	0.40	0.50	0.60	0.70	0.80	0.90	1.00	1.20	1.40	1.60	1.80	2.00
½	5.5	7.8	9.5	11.0	12.3	13.5	14.5	15.6	16.5	17.4	19.0	20.6	22.0	23.3	24.6
¾	6.1	8.7	10.6	12.3	13.7	15.1	16.3	17.4	18.4	19.4	21.3	23.0	24.6	26.1	27.5
1	6.9	9.7	11.9	13.8	15.4	16.9	18.2	19.5	20.6	21.8	23.8	25.7	27.5	29.2	30.8
1 ½	8.3	11.7	14.3	16.5	18.5	20.3	21.9	23.4	24.8	26.2	28.6	30.9	33.1	35.1	37.0
2	9.2	10.1	16.0	18.5	20.7	22.6	24.5	26.2	27.7	29.2	32.0	34.6	37.0	39.2	41.4
2 ½	10.2	14.4	17.6	20.3	22.7	24.9	26.9	28.8	30.5	32.2	35.2	38.1	40.7	43.2	45.5
3	11.2	15.9	19.4	23.4	25.1	27.5	29.7	31.7	33.7	35.5	38.9	42.0	44.9	47.6	50.2
4	12.7	18.0	22.0	25.5	28.5	31.2	33.7	36.0	38.2	40.2	44.1	47.6	50.9	54.0	56.9
6	15.4	21.8	26.7	30.9	34.5	37.8	40.9	43.7	46.3	48.8	53.5	57.8	61.8	65.5	69.1
8	17.6	24.9	30.5	35.2	39.6	43.2	46.6	49.8	52.9	55.7	61.0	65.9	70.5	74.8	78.8
10	19.7	27.8	34.1	39.3	44.0	48.2	52.0	55.6	59.0	62.2	68.1	73.6	78.7	83.5	88.0
12	21.4	30.3	37.1	42.8	47.9	52.5	56.7	60.6	64.3	67.7	74.2	80.2	85.7	90.9	95.8
14	22.4	31.7	38.9	44.9	50.2	55.0	59.4	63.5	67.3	71.0	77.8	84.0	89.8	95.2	100
16	24.0	33.9	41.6	48.0	53.7	58.8	63.5	67.9	72.0	75.9	83.1	89.8	96.0	102	107
18	25.5	36.0	44.1	50.9	56.9	62.4	67.3	72.0	76.4	80.5	88.2	95.2	102	108	114
20	26.8	37.9	46.5	53.7	60.0	65.7	71.0	75.9	80.5	84.9	93.0	100	107	114	120
22	28.1	39.8	48.7	56.3	62.9	68.9	74.5	79.6	84.4	89.0	97.5	105	113	119	126
24	29.4	41.6	50.9	58.8	65.7	72.0	77.8	83.1	88.2	93.0	102	110	118	125	131
26	30.6	43.3	53.0	61.2	68.4	74.9	80.9	86.5	91.8	96.7	106	114	122	130	137
28	31.7	44.9	55.0	63.5	71.0	77.8	84.0	89.8	95.2	100	110	119	127	135	142
30	32.9	46.5	56.9	65.7	73.5	80.5	86.9	93.0	98.6	104	114	123	131	139	147

TABLE 2 - Pipe Fit-Up Tolerances For Non Strain Sensitive Piping

NPS (inches)	Misfit Variation In Any Directions (inches)														
	0.10	0.20	0.30	0.40	0.50	0.60	0.70	0.80	0.90	1.00	1.20	1.40	1.60	1.80	2.00
½	3.9	5.5	6.7	7.8	8.7	9.5	10.3	11.0	11.7	12.3	13.5	14.5	15.6	16.5	17.4
¾	4.3	6.1	7.5	8.7	9.7	10.6	11.5	12.3	13.0	13.7	15.1	16.3	17.4	18.4	19.4
1	4.9	6.9	8.4	9.7	10.9	11.9	12.9	13.8	14.6	15.4	16.9	18.2	19.5	20.6	21.8
1 ½	5.8	8.0	10.1	11.7	13.1	14.0	15.5	16.5	17.5	18.5	20.0	21.9	23.4	24.8	26.0
2	6.5	9.2	11.0	13.1	14.6	16.0	17.3	18.5	19.6	20.7	22.6	24.5	26.2	27.7	29.2
2 ½	7.2	10.2	12.5	14.4	16.1	17.6	19.0	20.3	21.6	22.7	24.9	26.9	28.8	30.5	32.2
3	7.9	11.2	13.7	15.9	17.7	19.4	21.0	22.4	23.8	25.1	27.5	29.7	31.7	33.7	35.5
4	9.0	12.7	15.6	18.0	20.1	22.0	23.8	25.5	27.0	28.5	31.2	33.7	36.0	38.2	40.2
6	10.9	15.4	18.9	21.8	24.4	26.7	28.9	30.9	32.8	34.5	37.0	40.9	43.7	46.0	48.8
8	12.5	17.6	21.6	24.9	27.9	30.5	33.0	35.2	37.4	39.4	43.2	46.6	49.8	52.9	55.7
10	13.9	19.7	24.1	27.9	31.1	34.1	36.8	39.1	41.7	44.0	48.2	52.0	55.6	59.0	62.2
12	15.1	21.4	26.2	30.3	33.9	37.1	40.1	42.8	45.4	47.9	52.5	56.7	60.6	64.0	67.7
14	15.9	22.6	27.5	31.7	35.5	38.9	42.0	44.9	47.6	50.2	55.0	59.4	63.5	67.0	71.0
16	17.0	24.0	29.4	33.9	37.9	41.6	44.9	48.0	50.9	53.7	58.8	63.5	67.9	72.0	75.9
18	18.0	25.5	31.2	36.0	40.2	44.1	47.6	50.9	54.0	56.9	62.4	67.3	72.0	76.4	80.5
20	19.0	26.8	32.9	37.9	42.4	46.5	50.2	53.7	56.9	60.0	65.7	71.0	75.9	80.5	84.9
22	19.9	28.1	34.5	39.8	44.5	48.7	52.6	56.3	59.7	62.9	68.9	76.5	79.6	84.4	89.0
24	20.8	29.4	36.0	41.6	46.4	50.9	55.0	58.8	62.4	65.7	72.0	77.8	83.1	88.2	93.0
26	21.6	30.6	37.5	43.3	48.4	53.0	57.2	61.2	64.9	68.4	74.9	80.9	86.5	91.8	96.7
28	22.4	31.7	38.9	44.9	50.2	55.0	59.6	61.5	67.3	71.0	77.8	84.0	89.8	95.2	100
30	23.2	32.9	40.2	46.5	52.0	56.9	61.5	65.7	69.7	73.5	80.5	86.9	93.0	98.6	104

EXAMPLE:

Figure 1 illustrates a simple two-ended piping system with three directions of misfit at the final closure point. Each direction of misfit must be evaluated separately as follows.

For the ΔX misfit of 0.50"

The total length of piping perpendicular to ΔX (six legs) equals 74 feet; the minimum length required for a 0.50" misfit in 10" piping in Table 1 is 44.0 feet. Since the available piping exceeds this, the misfit is acceptable.

For the ΔY misfit of 0.75"

The total length of piping perpendicular to ΔY (six legs) equals 119 feet; the minimum length required for a 0.75" misfit in 10" piping in Table 1 is 53.8 feet. Since the available piping exceeds this, this misfit is also acceptable.

For the ΔZ misfit of 0.40"

The total length of piping perpendicular to ΔZ (four legs) equals 77 feet; the minimum length required for 0.40" misfit in Table 1 is 39.3 feet. Since the available piping exceeds this, the ΔZ misfit is acceptable, as well.

In this example, since all directions of misfit are within the allowance limitations, the piping may be cold-pulled to fit-up alignment.

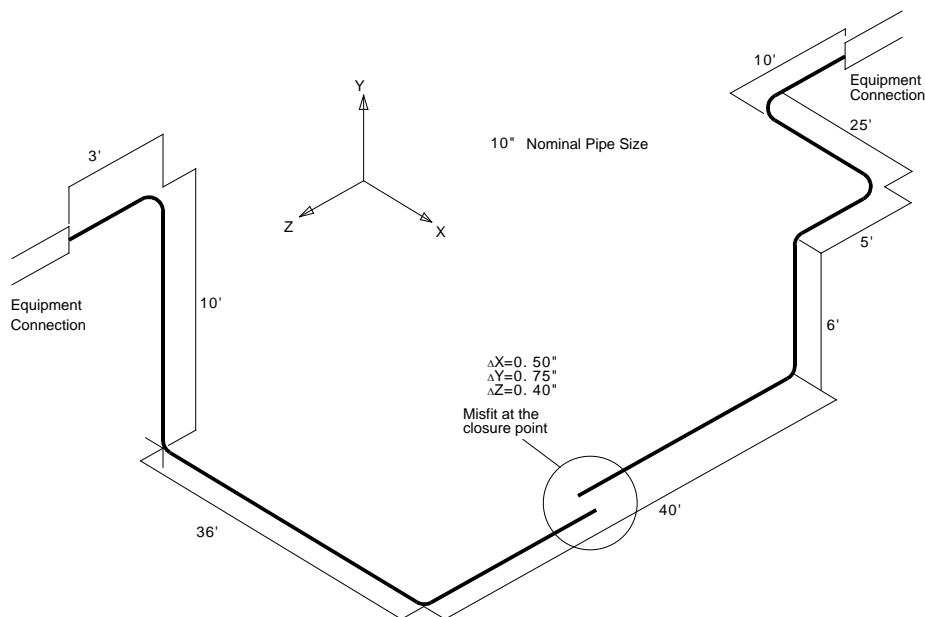

FIGURE 1

FLANGED JOINTS

The ASME B31.3 Code provides a rotational misalignment criterion for flanged Joints. Rotational misalignment is the amount the flanges are out-of-parallel. The Code criterion requires that prior to bolting, flange faces shall be aligned to the design plane within 1/16 in./ft measured across any diameter. During field assembly these tolerances may be difficult to achieve, especially for small flanges. Allowable flange rotational misalignments above those in the Code are provided in Table 3 for flange assemble with the limitations provided below. Table 3 provides an allowable gap based on the distance between two closest supports as shown in Figure 2.

The gap values provided in Table 3 apply to flanges fabricated to the following listed standards: ASME B16.5, AWWA C207, and MSS SP-44.

The flanges shall be assembled using the flange assembly procedure in Appendix E of this procedure.

The allowable gap values provided are to be compared to measurements taken prior to applying any preload (torque) to the flange bolts.

When these allowable gap values are applied, the required bolt torque to assemble the flange should be those provided in Appendix E with a 20% increase.

When these allowable gap values are applied during assembly, it is required to recheck the gap between the flange faces after 1/3 of the total required torque is applied to the bolts. After 1/3 of the torque is applied to the bolts, the maximum difference in gap must be within the ASME B31.3 requirements (flange faces must be parallel to within 1/16 in./ft measured across any diameter). If the gap is not within the B31.3 requirement after 1/3 of the total torque is applied rework or an engineering evaluation is required.

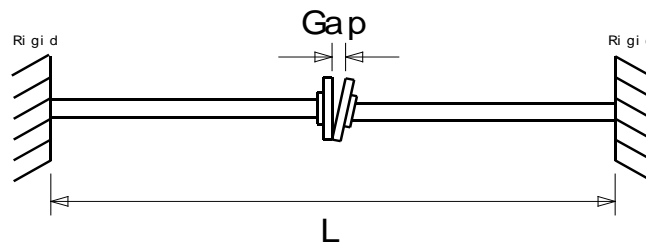

FIGURE 2

Table 3 -- Allowable Flange Gap (in.)

Minimum Length "L" Between Supports (in.)	Pipe Sizes - NPS										
	½	¾	1	1 ½	2	3	4	6	8	10	12
10	0.092	0.082	0.071	0.058	0.056	0.047	0.044	0.037	0.035	0.033	0.033
14	0.129	0.114	0.100	0.081	0.078	0.066	0.062	0.051	0.048	0.046	0.046
18	0.166	0.147	0.129	0.105	0.100	0.085	0.080	0.066	0.062	0.059	0.059
22	0.203	0.180	0.157	0.128	0.123	0.104	0.097	0.081	0.076	0.072	0.072
26	0.240	0.212	0.186	0.151	0.145	0.123	0.115	0.095	0.090	0.086	0.086
30	0.277	0.245	0.214	0.174	0.167	0.142	0.133	0.110	0.104	0.099	0.099
34	0.314	0.278	0.243	0.198	0.190	0.161	0.150	0.125	0.118	0.112	0.112
38	0.351	0.311	0.272	0.221	0.212	0.180	0.168	0.139	0.134	0.125	0.125
42	0.389	0.344	0.300	0.244	0.235	0.199	0.186	0.154	0.145	0.138	0.138
46	0.425	0.377	0.329	0.268	0.257	0.218	0.203	0.169	0.159	0.151	0.151
50	0.463	0.410	0.358	0.291	0.279	0.237	0.221	0.183	0.173	0.164	0.165
54	0.500	0.443	0.387	0.314	0.302	0.256	0.234	0.198	0.188	0.178	0.178
58	0.538	0.476	0.415	0.338	0.324	0.275	0.256	0.213	0.201	0.191	0.191
62	0.576	0.509	0.444	0.361	0.346	0.294	0.274	0.227	0.214	0.204	0.204
66	0.614	0.542	0.473	0.384	0.369	0.313	0.292	0.242	0.228	0.217	0.217
70	0.652	0.575	0.502	0.408	0.391	0.332	0.309	0.257	0.242	0.230	0.230
74	0.690	0.609	0.531	0.431	0.414	0.351	0.327	0.271	0.256	0.243	0.244
78	0.728	0.642	0.560	0.455	0.436	0.369	0.345	0.286	0.270	0.256	0.257
82	0.767	0.676	0.589	0.478	0.458	0.388	0.362	0.301	0.284	0.270	0.267
86	0.805	0.710	0.618	0.502	0.481	0.407	0.380	0.315	0.297	0.283	0.283
90	0.844	0.743	0.647	0.525	0.503	0.426	0.398	0.330	0.311	0.296	0.296
94	0.883	0.777	0.677	0.549	0.526	0.445	0.416	0.345	0.325	0.309	0.309
98	0.922	0.811	0.706	0.572	0.548	0.464	0.433	0.356	0.339	0.322	0.323
102	0.962	0.845	0.735	0.596	0.571	0.483	0.451	0.374	0.353	0.335	0.336
106	1.002	0.880	0.765	0.619	0.593	0.502	0.469	0.389	0.367	0.349	0.349
110	1.041	0.914	0.794	0.643	0.616	0.521	0.486	0.404	0.380	0.362	0.362

APPENDIX G – COMPONENT IDENTIFICATION

The ASME B31.3 Code requires random examination of materials and components to ensure conformance to listed specifications and standards. B31.3 also requires these materials to be free from defects. Component standards and specifications have various marking requirements. The intent of this appendix is to provide a convenient easy-to-use summary of the marking requirements for several commonly used piping components.

TABLE 1 - Generic Marking Standards and Requirements

Standard	Title and Requirements
MSS SP-25	<p><i>Standard Marking System for Valves, Fittings, Flanges and Unions</i></p> <ol style="list-style-type: none"> 1. Manufacturer’s Name or Trademark 2. Rating Designation 3. Material Designation 4. Melt Designation - as required by specification 5. Valve Trim Identification - valves only when required 6. Size Designation 7. Identification of Threaded Ends 8. Ring-Joint Facing Identification 9. Permissible Omission of Markings <p><i>Specific Marking Requirements</i></p> <ul style="list-style-type: none"> Marking Requirements for Flanges, Flanged Fittings, and Flanged Unions Marking Requirements for Threaded Fittings and Union Nuts Marking Requirements for Welding and Solder Joint Fittings and Unions Marking Requirements for Non-Ferrous Valves Marking Requirements for Cast Iron Valves Marking Requirements for Ductile Iron Valves Marking Requirements for Steel Valves

[MSS SP-25](#) is the most commonly used marking standard. It contains a variety of specific marking requirements that are too lengthy to list in this appendix; please refer to it when necessary to confirm the markings on a component.

The remainder of this appendix contains marking requirements divided into the following tables:

Table	Has marking requirements for
2	Piping and Tubing
3	Flanges and Flanged Fittings
4	Fittings (includes welded and threaded fittings)
5	Valves
6	Fasteners

TABLE 2 -- Pipe and Tube

Standard	Title and Marking Requirements
ASTM A53	Pipe, Steel, Black and Hot-Dipped, Zinc Coated, Welded and Seamless 1. Name of Brand of Manufacturer 2. Kind of Pipe (e.g. ERW B, XS) 3. Specification Number 4. Length
ASTM A106	Seamless Carbon Steel Pipe for High-Temperature Service 1. Marking requirements of A530/A530M 2. Heat Number 3. Hydro/NDE Marking 4. "S" for supplementary requirements as specified (stress-relieved annealed tubes, air underwater pressure test, and stabilizing heat treatment) 5. Length 6. Schedule Number 7. Weight on NPS 4 and larger
ASTM A269	Seamless and Welded Austenitic Stainless Steel Tubing for General Service 1. Marking requirements of A450/A450M 2. Seamless or Welded
ASTM A312	Standard Specification for Seamless, Welded, and Heavily Cold Worked Austenitic Stainless Steel Pipes 1. Marking requirements of A530/A530M 2. Manufacturer's Private Identifying Mark 3. Seamless or Welded
ASTM A530/A530A	Standard Specification for General Requirements for Specialized Carbon and Alloy Steel Pipe 1. Manufacturer's Name 2. Specification Grade
ASTM A450/A450M	Standard Specification for General Requirements for Carbon –and Low Alloy Steel Tube 1. Manufacturer's Name 2. Specification Grade
ASTM B88	Specification for Seamless Copper Water Tube 1. Name of Trademark of Manufacturer (interval $\leq 1\frac{1}{2}$ ft) 2. Type (i.e. K, L, or M) (interval $\leq 1\frac{1}{2}$ ft) Straight Lengths 1. Type of the tube, name or trademark of the manufacturer, or both, and the country of origin repeated at intervals not greater than 3 ft. 2. Continuous colored stripe, symbol or logo not less than 3/16" high.
AWWA C115/A21.15	Flanged Ductile-Iron Pipe with Ductile-Iron or Gray-Iron Threaded Flanges 1. Length and weight shown of each pipe. 2. Manufacturer's Mark 3. Country where cast. 4. DI if ductile iron and GI if gray iron.

Section REF References

Rev. 0, 9/17/2014

REF-3 ASME B31.3 Process Piping Guide

Standard	Title and Marking Requirements
AWWA C900	<p><i>Polyvinyl Chloride (PVC) Pressure Pipe and Fabricated Fittings, 4 in. Through 12 in., for Water Distribution</i> Markings on pipe shall include the following at not more than 5 ft. intervals.</p> <ol style="list-style-type: none"> 1. Nominal size and OD base (e.g. 4 CI) 2. PVC 3. Dimension ratio (e.g. DR 25) 4. AWWA pressure class (e.g. PC 100) 5. Manufacturer's name or trademark 6. AWWA designations (AWWA C900) 7. Seal of testing agency is optional <p>Couplings contain the same markings except the AWWA pressure class is not required.</p>
AWWA C905	<p><i>Polyvinyl Chloride (PVC) Pressure Pipe and Fabricated Fittings, 14 in. Through 48 In., for Water Transmission and Distribution.</i> Markings on pipe shall include the following at not more than 5 ft. intervals.</p> <ol style="list-style-type: none"> 1.Nominal size and OD base (e.g. 24 CI) 2.PVC 3.Dimension ratio (e.g. DR 25) 4.AWWA pressure class (e.g. PC 160) 5.Manufacturer's name or trademark 6.AWWA designations (AWWA C905) 7.Manufacturer's production code, including day, month, year, shift, plant, and extruder of manufacturer.

TABLE 3 -- Flanges and Flanged Fittings

Standard	Title and Marking Requirements																							
ASME B16.1	<p>Gray Iron Pipe Flanges and Flanged Fittings Classes 25, 125, and 250</p> <p>1. Manufacturer's Name or Trademark and Numeral as shown below:</p> <table border="1"> <thead> <tr> <th>Rating Class</th> <th>Size</th> <th>Numeral</th> </tr> </thead> <tbody> <tr> <td>25</td> <td>All</td> <td>25</td> </tr> <tr> <td rowspan="3">125</td> <td>1 to 12</td> <td>125</td> </tr> <tr> <td>14 to 24</td> <td>100</td> </tr> <tr> <td>30 to 48</td> <td>50</td> </tr> <tr> <td rowspan="3">250</td> <td>1 to 12</td> <td>250</td> </tr> <tr> <td>14 to 24</td> <td>200</td> </tr> <tr> <td>30 to 48</td> <td>100</td> </tr> <tr> <td>800</td> <td>2 to 12</td> <td>800</td> </tr> </tbody> </table>	Rating Class	Size	Numeral	25	All	25	125	1 to 12	125	14 to 24	100	30 to 48	50	250	1 to 12	250	14 to 24	200	30 to 48	100	800	2 to 12	800
Rating Class	Size	Numeral																						
25	All	25																						
125	1 to 12	125																						
	14 to 24	100																						
	30 to 48	50																						
250	1 to 12	250																						
	14 to 24	200																						
	30 to 48	100																						
800	2 to 12	800																						
ASME B16.5	<p>Pipe Flanges and Flanged Fittings</p> <p>1. Manufacturer's Name or Trademark 2. ASTM Specification and Grade 3. Rating Class 4. "B16" 5. Size</p>																							
ASME B16.24	<p>Cast Copper Alloy Pipe Flanges and Flanges Fittings, Class 150, 300, 600, 900, 1500 and 2500</p> <p>Except as noted below, flanges and flanged fittings shall be marked as required in MSS SP-25.</p> <p>1. Manufacturer's Name or Trademark 2. ASTM Specification and Grade 3. Rating Class 4. "B16" 5. Size</p>																							
ASME B16.36	<p>Orifice Flanges</p> <p>1. Flanges shall be marked as required by ASME B16.5 2. For welding neck flanges only, the bore diameter shall be marked.</p>																							
ASME B16.42	<p>Ductile Iron Pipe Flanges and Flanged Fittings Classes 150 and 300</p> <p>Except as noted below, flanges and flanged fittings shall be marked as required in MSS SP-25.</p> <p>1. Manufacturer's Name or Trademark 2. Material - "DUCTILE" or D.I. if space does not permit 3. Rating Class 4. "B16" 5. Size</p>																							
MSS SP-44	<p>Steel Pipeline Flanges</p> <p>1. Marked in accordance with MSS SP-25. 2. "PL" precedes the grade symbol marking.</p>																							
MSS SP-51	<p>Class 150LW Corrosion Resistant Flanges and Cast Flanged Fittings</p> <p>1. Manufacturer's name or trademark. 2. Class designation. 3. Material designation. 4. Melt identification. 5. Size.</p>																							

TABLE 4 -- Fittings

Standard	Title and Marking Requirements
AWWA C110/A21.10	<p>Ductile-Iron and Gray-Iron Fittings</p> <ol style="list-style-type: none"> 1. Pressure rating. 2. Nominal diameter. 3. Manufacturer's identification. 4. Country where cast. 5. Degrees or fractions for all bends. 6. "DI" or "Ductile" for ductile iron.
AWWA C111/A21.11	<p>Rubber-Gasket Joints For Ductile-Iron Pressure Pipe and Fittings</p> <ol style="list-style-type: none"> 1. Pipe and fittings having push-on joints shall be marked with the proprietary name or trademark of the joint. 2. Bolts and nuts shall have a mark to identify the material and producer.
AWWA C153/A21.53	<p>Ductile Iron Compact Fittings</p> <ol style="list-style-type: none"> 1. C153 2. Pressure rating. 3. Nominal diameter. 4. Manufacturer's identification. 5. Country where cast. 6. "DI" or "Ductile" for ductile iron. 7. Degrees or fractions for all bends.
AWWA C907	<p>Injection-Molded Polyvinyl Chloride (PVC) Pressure Fittings, 4 In. Through 12 In. for Water, Wastewater, and Reclaimed Water Service</p> <ol style="list-style-type: none"> 1. Nominal size 2. Code identifying the production run. 3. PVC 4. AWWA identification number for this standard (AWWA C907) 5. Pressure Class (cL150). 6. Manufacturer's name or trademark. 7. Numbers of degrees, or fraction of a circle, on all bends.
ASME B16.3	<p>Malleable Iron Threaded Fittings, Classes 150 and 300</p> <ol style="list-style-type: none"> 1. Class 150 - Manufacturer's Name or Trademark 2. Class 300 - Manufacturer's Name or Trademark <ul style="list-style-type: none"> - Numerals "300" - Letters "MI" for malleable iron - Size - Other marking as permitted by MSS SP-25
ASME B16.4	<p>Gray Iron Threaded Fittings, Classes 125 and 250</p> <ol style="list-style-type: none"> 1. Class 125 - Manufacturer's Name or Trademark 2. Class 250 - Manufacturer's Name or Trademark <ul style="list-style-type: none"> - Numerals "250"
ASME B16.9	<p>Factory-Made Wrought Butt Welding Fittings</p> <ol style="list-style-type: none"> 1. Manufacturer's Name or Trademark 2. Material and Product Identification (ASTM or ASME grade symbol). 3. "WP" in grade symbol. 4. Schedule number or nominal wall thickness. 5. NPS

REF-3 ASME B31.3 Process Piping Guide

Standard	Title and Marking Requirements
ASME B16.11	<p>Forged Fittings, Socket-Welding and Threaded</p> <ol style="list-style-type: none"> 1. Manufacturer's Name or Trademark. 2. Material identification in accordance with the appropriate ASTM. 3. Product conformance symbol, either "WP" or "B16". 4. Class designation - 2000, 3000, 6000, or 9000. <p>Where size and shape do not permit all of the above markings, they may be omitted in the reverse order given above.</p>
ASME B16.14	<p>Ferrous Pipe Plugs, Bushings, and Locknuts with Pipe Threads</p> <ol style="list-style-type: none"> 1. Manufacturer's Name or Trademark except where impractical
ASME B16.18	<p>Cast Copper Alloy Solder Joint Pressure Fittings</p> <ol style="list-style-type: none"> 1. Manufacturer's Name or Trademark in accordance with MSS SP-25. Markings of fittings less than ½ " is optional and may be omitted if not practical.
ASME B16.22	<p>Wrought Copper and Copper Alloy Solder Joint Pressure Fittings</p> <ol style="list-style-type: none"> 1. Manufacturer's Name or Trademark in accordance with MSS SP-25 2. Markings may be omitted from any fitting where it may damage soldering surfaces.
ASME B16.28	<p>Wrought Steel Buttwelding Short Radius Elbows and Returns</p> <ol style="list-style-type: none"> 1. Manufacturer's Name or Trademark 2. Material (ASTM Specification and Grade); prefix "WP" must appear in the grade symbol 3. Schedule number or nominal wall thickness 4. Size
ASME B16.39	<p>Malleable Iron Threaded Pipe Unions</p> <ol style="list-style-type: none"> 1. Unions shall be marked on the nut with the manufacturer's name or trademark and nominal pressure class except on bar stock unions where marking is impractical. 2. Additional markings as permitted by MSS SP-25 may be used.
MSS SP-43	<p>Wrought and Fabricated Butt-Welding Fittings for Low Pressure, Corrosion Resistant Applications</p> <ol style="list-style-type: none"> 1. Manufacturer's Name or Trademark 2. "CR" followed by ASTM or AISI material identification symbol 3. Schedule number or nominal wall thickness designation 4. Size
MSS SP-79	<p>Socket-Welding Reducer Inserts</p> <ol style="list-style-type: none"> 1. Markings in accordance with MSS SP-25. Markings are to be located close to the reduced opening so they will be visible after welding. 2. Markings shall include (but not limited to) the following: <ul style="list-style-type: none"> - Manufacturer's Name of Trademark - Material Identification - Class Designation (3000 or 6000) - Size
MSS SP-83	<p>Steel Pipe Unions, Socket-Welding and Threaded</p> <ol style="list-style-type: none"> 1. Markings in accordance with MSS SP-25 2. Markings shall include (but not limited to) the following: <ul style="list-style-type: none"> - Manufacturer's Name of Trademark - Material Identification (ASTM A105/A182) - Class 3000 - Size

TABLE 5 -- Valves

Standard	Title and Marking Requirements
API Standard 602	<p>Compact Steel Gate Valves - Flanged, Threaded, Welded, and Extended Body Ends</p> <ol style="list-style-type: none"> 1. Valves shall be marked in accordance with the requirements of ASME B16.34. 2. Each valve shall have a corrosion-resistant metal identification plate with the following information: <ul style="list-style-type: none"> - Manufacturer - Manufacturer's model, type, or figure number - Size - Applicable pressure rating at 100°F - Body material - Trim material 3. Valve bodies shall be marked as follows: <ul style="list-style-type: none"> - Threaded-end or socket-welding-end valves - 800 or 1500 - Flanged-end valves - 150, 300, 600, or 1500 - Buttwelding-end valves - 150, 300, 600, 800, or 1500
ASME B16.34	<p>Valves - Flanged, Threaded and Welding End</p> <ol style="list-style-type: none"> 1. Manufacturer's Name or Trademark 2. Valve Body Material <i>Cast Valves</i> - Heat Number and Material Grade <i>Forged or Fabricated Valves</i> - ASTM Specification and Grade 3. Rating 4. Size 5. Where size and shape do not permit all of the above markings, they may be omitted in the reverse order given above. 6. For all valves, the identification plate shall show the applicable pressure rating at 100°F and other markings required by MSS SP-25.
MSS SP-71	<p>Gray Iron Swing Check Valves, Flanged and Threaded Ends</p> <ol style="list-style-type: none"> 1. Markings shall conform to MSS SP-25
MSS SP-72	<p>Ball Valves with Flanged or Butt-welding Ends for General Service</p> <ol style="list-style-type: none"> 1. Marker in accordance with MSS SP-25.
MSS SP-78	<p>Gray Iron Plug Valves, Flanged and Threaded Ends</p> <ol style="list-style-type: none"> 1. Markings conform to MSS SP-25.
MSS SP-80	<p>Bronze Gate, Globe, Angle and Check Valves</p> <ol style="list-style-type: none"> 1. Markings shall conform to MSS SP-25. 2. All bronze check valve bodies shall be marked to indicate the direction of flow by means of an arrow cast on the valve body or by the word "in" or "inlet" cast or stamped on the inlet end of the body.
MSS SP-85	<p>Gray Iron Globe and Angle Valves, Flanged and Threaded Ends</p> <ol style="list-style-type: none"> 1. Markings shall conform to MSS SP-25

TABLE 6 -- Fasteners

Standard	Title and Marking Requirements
ASTM 193	<p>Specification for Alloy-Steel and Stainless Steel Bolting for High-Temperature or High Pressure Service and Other Special Purpose Applications</p> <ol style="list-style-type: none"> Grade or manufacturer's identification symbols shall be applied to one end of studs 3/8" in diameter and larger and to the heads of bolts 1/4 " in diameter and larger.
ASTM 194	<p>Specification for Carbon and Alloy Steel Nuts for Bolts for High-Pressure and High-Temperature Service, or Both</p> <ol style="list-style-type: none"> Manufacturer's identification mark. Grade and process of manufacture (e.g. 8F indicates nuts that are hot-forged or cold-forged)
ASTM 307	<p>Specification for Carbon Steel Bolts, Studs, and Threaded Rod 60 000 PSI Tensile Strength</p> <ol style="list-style-type: none"> Manufacturer's identification mark. All bolt heads, one end of studs 3/8" and larger, and whenever feasible studs less than 3/8", shall be marked with a grade material.
ASTM 563	<p>Specification for Carbon and Alloy Steel Nuts</p> <ol style="list-style-type: none"> Grades O, A, and B are not required to be marked unless identified as such by the purchaser. Grade D, DH, DH3 shall be marked with the symbol HX3 on one face. Heavy hex nuts made to the requirements of DH3 are marked with HX3 on one face. Grades C, C3, D, DH, and DH3 and hex nuts made to the requirements of DH3, are marked with the manufacturers symbol.

APPENDIX H – LEAK/PRESSURE TESTING

PURPOSE

This Appendix provides guidance for hydrostatic and pneumatic tests. The specific code requirements are contained in paragraph 345 of ASME B31.3.

SCOPE

The information in this Appendix applies to the testing of metallic Category D and Normal fluid service process piping systems constructed to ASME B31.3 “Process Piping”. Nonmetallic piping and other fluid service categories have additional requirements.

GENERAL

TEST PREPARATION

- 1) All Code and design required examinations shall be complete prior to testing
- 373 A preliminary walk-down of the piping to be tested shall be made. Test personnel shall correct and/or identify test boundaries, any problems, incomplete items, joint access, fill points, vent points and any scaffolding required.
- 374 All joints, including welds and mechanical joints are to be left un-insulated and exposed for examination during the test, except that joints previously tested may be insulated or covered.
- 375 Hangers and supports shall be placed in the proper position prior to the filling of the system to be tested.
- 376 Piping designed for vapor or gas shall be provided with additional temporary supports, if necessary to support the weight of the test liquid, as designated by the designer. Spring hangers should be placed in the locked position.
- 377 Expansion joints shall be provided with temporary restraint if required for additional pressure load under test, or shall be isolated from the test.
- 378 The test personnel shall assure that the components (e.g. instruments, valves, etc.) that are not to be subjected to the pressure test, are either disconnected from the piping or isolated by blind flanges or other means during the tests. Valves may be used for isolation, provided the valve (including the closure mechanism) is suitable for the proposed test pressure.
- 379 A flanged joint at which a blank is inserted to isolate other equipment during the test need not be examined for leaks. These joints should be leak tested during initial service.
- 380 If a pressure test is to be maintained for a period of time and the test liquid in the system is subject to changes in temperature, precautions shall be taken to avoid excessive pressure due to thermal expansion or freezing.
- 381 A preliminary air test at not more than 25 psi gage pressure may be made prior to hydrostatic test in order to locate major leaks.
- 382 A test record shall be made for each leak test. The record shall include the following:
 - 383 Date of test
 - 384 Identification of piping to be tested (test boundaries)
 - 385 Test fluid

REF-3 ASME B31.3 Process Piping Guide

- 386 Test pressure
- 387 Certification of the examiner
- 388 An example Pressure Test Record is provided at the end of this appendix.
- 389 Following hydrostatic or pneumatic leak testing, the piping system should be cleaned, and dried if necessary. Refer to Appendix K for cleaning techniques.
- 390 Prior to in-service leak test, the piping system should be cleaned, and dried if necessary. Refer to Appendix K for cleaning techniques.
- 391 During Hydrostatic testing or in-service leak testing, strainers should be used to protect equipment against the introduction of construction debris or dirt.

HYDROSTATIC LEAK TEST

TEST FLUID

- 1) The test fluid shall be water unless there is a possibility of damage due to freezing, or if the process or piping material would be adversely affected by water. In that case other suitable test fluids may be used. Special precautions are required if the test fluid is toxic or flammable.
- 392 The temperature of the test fluid should be no less than 40°F in piping systems subject to brittle fracture (i.e. carbon steel).
- 393 If the test fluid temperature produces condensation on the piping exterior surface, the water shall be heated to a temperature above the dew point or the test shall be postponed to a time when the dew point temperature has changed sufficiently such that condensation will not occur on the piping exterior surface.
- 394 Material and test water temperature shall be approximately equal prior to pressurizing the system.
- 395 High points in the system shall be vented so that air will be displaced while the system is being filled with the test fluid.
- 396 The operator shall take adequate measures to ensure that the piping system is not over-pressurized during hydrostatic testing. Adequate measures include a relief valve, or a dedicated operator to monitor pressure, or dual pressure regulators, etc.

TEST PRESSURE

- 1) The minimum hydrostatic test pressure for metallic piping shall be per the following equation.
- $$P_T = 1.5 \times P_D \times S_T/S_D$$
- where: P_T = minimum test gage pressure
 P_D = internal design gage pressure
 S_T = allowable stress value at test temperature
 S_D = allowable stress value at design temperature
- Note: The maximum allowable value of S_T/S_D is 6.5
- 397 When a maximum test pressure is specified, the test pressure shall not exceed this amount.
- 398 When no maximum test pressure is specified, the test shall not be greater than 110% of the minimum.

REF-3 ASME B31.3 Process Piping Guide

- 399 When using water, static head due to differences in the elevation of the top of the piping system and the elevation of the test gage shall be accounted for in pressuring the piping system to be tested by the following equations:

$$SH \text{ (psi)} = (HE - GE) \times 0.433$$

$$P_{ST} = P_T + SH$$

where: HE = high point elevation (ft)

GE = gage point elevation (ft)

SH = static head (psi)

P_{ST} = minimum test gage pressure corrected for static head

0.433 = conversion factor (ft of water to psi)

- 400 Pressure gages should be connected directly to the piping. Calibrated pressure gages shall be used in all Code testing. Pressure gage range should exceed the intended test pressure by approximately double but in no case should the range be less than one and one-half (1 ½) times the test pressure.

HYDROSTATIC TESTING OF PIPING WITH VESSELS AS A SYSTEM

- 1) Where the test pressure of piping attached to a vessel is the same as or less than the test pressure for the vessel, the piping may be tested with the vessel at the test pressure of the piping.
- 401 Where the test pressure of the piping exceeds the vessel test pressure and isolation is not considered practicable, the piping and the vessel may be tested together at the test pressure of the vessel, if approved by the design authority. The vessel test pressure must not be less than 77% of the piping test pressure.

EXAMINATION FOR LEAKS

- 1) Test personnel shall ensure the hydrostatic pressure is maintained for sufficient time to determine if there are any leaks. A minimum time of 10 minutes is required by Code. After the hydrostatic pressure time has been satisfied, all joints shall be examined visually for leaks.
- 402 Examination shall be made of all welds and mechanical joints. There shall be no visible evidence of leakage. Welds and joints previously tested need not be examined for leaks.
- 403 Leakage detected in welded joints shall be repaired by draining, repair welding, non-destructively examining in accordance with original requirements, and re-tested to the original test pressure.
- 404 Mechanical joint leakage at permanent joints shall be repaired, examined in accordance with original requirements, and re-tested to the original test pressure.

PNEUMATIC TESTING**PRECAUTIONS**

Pneumatic testing involves a hazard due to possible release of energy stored in compressed gas. Care must be taken to minimize the chance of brittle failure during testing by initially assuring the system is suitable for pneumatic testing. Pneumatic testing may be used in lieu of hydrostatic testing, recognizing the hazard of energy stored in compressed gas, when a

REF-3 ASME B31.3 Process Piping Guide

hydrostatic test is considered impracticable. Guidance for when to use a pneumatic test is provided below.

- 1) When components, appurtenances, or systems are so designed or supported that they cannot be safely filled with water.

- 405 When components, appurtenances, or systems, that are not readily dried, are to be used in services where traces of the testing medium cannot be tolerated.

TEST FLUID

Air or Nitrogen shall be used as a test medium unless otherwise specified by engineering. Special precautions are required if the test fluid is toxic or flammable.

TEST PRESSURE

- 1) The pneumatic test pressure shall be per the following equation.

$$P_T = 1.1 \times P_D$$

where:

P_T = test gage pressure

P_D = internal design gage pressure

- 406 Temporary test pressure relief device shall be provided during pneumatic testing. The set pressure shall not be higher than the test pressure plus the lesser of 50 psi or 10% of the test pressure.

EXAMINATION FOR LEAKS

- 1) The pressure in the piping system shall be increased gradually in steps providing sufficient time to allow the piping to equalize strains during the test. When the system pressure reaches the lesser of $\frac{1}{2}$ the test pressure or 25 psi a preliminary leak check of the system shall be made. Following the preliminary leak check the pressure shall be increased gradually until the test pressure is reached. The pressure shall then be reduced to the design pressure before examining for leaks.

- 407 Examination shall be made of all welds and mechanical joints. There shall be no visible evidence of leakage. Welds and joints previously tested need not be examined for leaks.

- 408 During pneumatic tests, all joints shall be examined with a bubble-producing solution specifically compounded for leak detection.

- 409 Leakage detected in welded joints shall be repaired by de-pressurizing, repair welding, non-destructively examined as the original, and re-tested to the original test pressure.

- 410 Mechanical joint leakage at permanent joints shall be repaired, examined as original, and re-tested to the original test pressure.

PIPING SUBJECT TO EXTERNAL PRESSURE**TEST METHOD**

Either the hydrostatic or pneumatic test method described above may be used to test externally pressured piping. The piping shall be tested at an internal gage pressure 1.5 times the external pressure, but not less than 15 psi.

PRESSURE TEST RECORD

[SAMPLE – Edit to suit but capture all data required for ASME B31 compliance]

TEST NUMBER:	PROJECT NO.:	PAGE 1 OF	
PROJECT NAME:			
TEST INFORMATION			
SYSTEM DESCRIPTION:			
DESCRIPTION OF TEST BOUNDARIES: (Attach Sketch Showing Boundaries as Required. P&ID Recommended)			
DESIGN TEMPERATURE:	DESIGN PRESSURE:		
TEST METHOD: <input type="checkbox"/> HYDROSTATIC <input type="checkbox"/> PNEUMATIC:			
TEST FLUID:	APPLICABLE CODE:		
TEST REQUIREMENTS			
REQUIRED TEST PRESSURE:	TEST FLUID TEMPERATURE:		
REQUIRED TEST DURATION:	AMBIENT TEMPERATURE:		
GAUGE PRESSURE CALCULATION (See Section 4.2.4)			
ELEVATION DIFFERENCE BETWEEN GAUGE AND HIGH POINT:			
X CONVERSION FACTOR:			
PLUS REQUIRED TEST PRESSURE:			
EQUALS REQUIRED GAUGE PRESSURE:			
TEST RESULTS			
TEST DATE:	START TIME:	<input type="checkbox"/> AM <input type="checkbox"/> PM	
	FINISH TIME:	<input type="checkbox"/> AM <input type="checkbox"/> PM	
ACTUAL GAUGE PRESSURE:			
TEST EQUIPMENT			
TYPE:	RANGE:	CAL. DATE:	CAL. DUE:
REMARKS:			
TEST ACCEPTANCE			
CODE EXAMINER:	DATE:		
CODE INSPECTOR:	DATE:		

APPENDIX I – STRESS ANALYSIS

This appendix provides a guide for Stress Analysis and Qualification for Compliance with ASME B31.3, paragraphs 302.3.5 Limits of Calculated Stresses Due to Sustained Loads and Displacement Strains, and 302.3.6 Limits of Calculated Stresses due to Occasional Loads of above ground piping.

Scope and Boundaries of Piping Systems

The qualification documentation for piping systems analyzed to the requirements of this procedure should include a system diagram (P&ID sketch) and a stress isometric indicating the scope and boundaries (end points) of the analysis. The isometric should include support location, type and direction, location of components and the coordinate system (For the purpose of uniformity, coordinates North = + X, Up = + Y and East = + Z are recommended).

The piping system analytical model should extend to in-line structural anchors (six-way restraints) or nozzles of anchored equipment. Otherwise, the analytical model should overlap into adjacent piping, beyond the scope of the system to be qualified. The extent of overlap should be sufficient to reflect the loading transmitted from the overlap onto the in-scope piping system.

For the purpose of analysis, branch lines can be decoupled from the header piping provided all of the following conditions are met:

- The ratio of branch to header pipe moment of inertia is such that $I_{\text{branch}} < I_{\text{header}} / 2S$
- The header pipe movements are properly considered in the analysis of the branch pipe
- When seismic qualification is required, the applied spectra should envelope the header pipe support attachment points

Applied boundary conditions include differential thermal expansion and dynamic anchor movements or gaps at building and equipment attachment points. Differential movements of less than ¼ " may be neglected, except at equipment nozzles.

Pipe Supports and Equipment Analytical Models

The stiffness of pipe supports and equipment should be considered in dynamic analysis. Supports and equipment may be considered to be rigid provided either one of the following conditions are met:

- The support or equipment fundamental frequency is greater than the frequency corresponding to the zero period acceleration
- The support or equipment stiffness exceeds the minimum rigid values of Table I-1

**Table I-1
Minimum Rigid Support and Equipment Stiffness**

Pipe Size	Translational Stiffness (lb/in)	Rotational Stiffness (in-lb/rad)
≤ ¾ "	1E4	1E6
1" to 2"	1E5	1E7
3" to 4"	5E5	5E7
≥ 6"	1E6	1E8

A rigid support or equipment may be assigned the stiffness values of Table I-1 or a larger stiffness. Otherwise, the actual support stiffness should be accounted for.

To reduce unnecessary iterations, it is important that stiffness values be rounded.

Section REF References

Rev. 0, 9/17/2014

REF-3 ASME B31.3 Process Piping Guide

One-way vertical downward supports may be modeled as two-way restraints in dynamic analysis, provided the following four conditions are met:

- The pipe, should it uplift (thermal + seismic up > deadweight down), will not fall off the support.
- The support can withstand a total applied downward load equal to twice the resultant vertical static load plus the calculated vertical dynamic load.
- The pipe span adjacent to the one-way support, on either side, does not contain impact sensitive equipment or components.
- The pipe span adjacent to the one-way support is not attached to an equipment nozzle.

The lateral restoring force of rod hangers may be included in the piping system model, as an equivalent linear lateral stiffness, ($k = \text{tributary weight of pipe span/rod length}$) from pin centerline to pipe center line provided the swing angle can be accommodated by the rod and anchor design.

Modeling Tolerances

Guidance on tolerances is provided in ASME B&PV Section III Appendix T – Recommended Tolerances for Reconciliation of Piping Systems. Layer tolerances may be applied where the applied stress is a small fraction of the allowable stress. Tolerance on segment lengths and fitting locations may be the larger of ± 1 foot or $\pm D/2$. Deviations between the analytical model and the as-built condition beyond the above tolerances must be reconciled.

Loading Conditions

The design documents shall specify the applicable loading, based on the applicable standard (such as IBC) or typical requirements. The following load combinations are provided for guidance.

LOAD COMBINATIONS FOR THE QUALIFICATION OF PIPING SYSTEMS

Normal (sustained)	$P_o + DW$
Normal (occasional)	$P_o + DW + FT_N$ or $P_o + DW + W_L$
Thermal	Th_N
Faulted	$P_o + DW + (FT_{FD}^2 + DBE^2)^{1/2}$ $P_o + DW + FT_F$ $P_o + DW + W_L$

Notes:

- P_o = Normal system operation pressure
- DW = Deadweight
- FT_i = Fluid transient loads, under plant condition i (normal sustained, normal occasional or faulted)
- Th_i = Thermal expansion or discontinuity stress, under plant condition i (normal sustained, normal occasional or faulted). Faulted thermal loads, Th_F , need not be considered in piping qualification, but should be considered in support qualification. Piping Thermal stresses are qualified separately from other applied loads, as defined in ASME III or B31.1
- W_L = Wind loads
- FT_{FD} = Faulted fluid transients which result from a DBE
- DBE = Design basis earthquake loads equal to the SRSS of inertia and anchor motion loads.

Stress Analysis

DEADWEIGHT ANALYSIS

The deadweight analysis should consider the piping and component weight, the insulation weight and the weight of fluids contained in the system.

THERMAL EXPANSION ANALYSIS

A thermal expansion analysis is recommended if one of the following conditions applies:

- The operating or maximum fluid temperature exceeds 150°F
- The piping is attached to equipment which has nozzle load criteria
- The piping flexibility is judged insufficient to accommodate thermal expansion.

Thermal expansion analysis should include header and equipment resultant thermal movements at the terminal and nozzle attachment points.

Thermal analysis shall consider the potential for flow stratification in horizontal lines subjected to low flow velocities and large temperature gradients from top to bottom of pipe, with a Richardson number $R_i > 1$, where:

$$R_i = \left(\frac{d\rho}{\rho} \right) \left(\frac{gD_i}{v^2} \right) l$$

where:

- ρ = density of fluid (a function of temperature)
- $d\rho$ = change in fluid density between max and min. temperature (top to bottom of pipe)
- g = gravitational constant
- D_i = pipe inside diameter
- v = flow velocity

PRESSURE ANALYSIS

This Appendix does not address the requirement for system sizing and process design such as pipe size (and minimum wall thickness), component ratings, reinforcement of openings, layout arrangements (including pressure relief) and testing (such as hydrostatic pressure testing). These requirements should be specified in the project or design documents, or referred to the applicable Code. Refer to Appendix A.

SEISMIC ANALYSIS

When seismic analysis is required, this analysis may be accomplished using static or dynamic methods, as permitted in the project specification.

STATIC SEISMIC ANALYSIS

The static seismic analysis is applied to a system or subsystem.

A static load should be calculated in accordance with the applicable standard (such as IBC) and is applied to the piping system, in each of three directions.

If the piping system is rigid, the static load may be equal to the envelope of the floor response spectra zero period accelerations.

REF-3 ASME B31.3 Process Piping Guide

The system response to each of the three one-directional static loadings shall be combined by SRSS to obtain the resultant system response, unless permitted otherwise by the applicable standard (for example, IBC-2000 permits a two-dimensional load combination, where the resultant seismic load is the largest of the east-west + vertical and north-south + vertical).

RESPONSE SPECTRA MODAL ANALYSIS

The applicable response spectra should envelope the spectra at all attachment points along the piping system, including the supports from decoupled headers, in the vicinity of the decoupled branch point.

The three directional response should be calculated by SRSS of the three unidirectional responses.

Modal combination should be by SRSS of modes, unless specified otherwise in the project requirements.

High frequency modes (beyond the zero period acceleration or 33 hertz) should be accounted for as described in USNRC Standard Review Plan NUREG-0800, Section 3.7.2.

Seismic anchor motions larger than $\frac{1}{4}$ inch should be evaluated.

The following considerations apply for the dynamic model of the piping system:

- 1) The number of dynamic degrees of freedom, and hence the number of lumped masses, should be selected so that all significant modes of vibration of the structure below 33 Hz are accurately represented. The location of masses will be dependent upon the piping support configuration. In addition, mass points should be established at concentrated weight locations (e.g., valves, flanges, large fittings) and at the centerline of eccentric masses (such as valve operators).

411 If a support mass is larger than 20% of an adjacent pipe lumped mass, the support mass should be considered in the model.

412 Valves with natural frequencies below the zero period acceleration shall be modeled to appropriately reflect their actual mass and frequency.

Damping of piping system for seismic Design Basis Earthquake response spectra modal analysis shall be 5% unless specified otherwise in project requirements.

TIME HISTORY ANALYSIS

Seismic time history analysis of a piping system should only be used as a last resort, where some of the conservatism inherent to the static or response spectra methods must be eliminated.

The analysis may be performed using either the direct integration procedure or the modal superposition procedure. In both approaches, careful consideration should be given to the numerical integration method being used and the time step of integration. The time step (dt) chosen should be sufficiently small to capture the significant portion of response and to ensure that excessive numerical damping is not being introduced into the response calculations.

For modal time-history superposition, care should be taken to ensure that all the significant modes of vibration are included in the analysis.

Responses from the individual modes of vibration included in the analysis may be combined by algebraic summation of the modal time histories of response at each time step to determine the individual component response time history.

The damping and energy dissipation shall be simulated using applicable procedures of Appendix N of ASME B&PV Code Section III.

REF-3 ASME B31.3 Process Piping Guide

When the three components of earthquake motion are statistically independent, time-history responses may be obtained individually for each of the three independent components and combined algebraically at each time step to obtain the combined response time history.

FLUID TRANSIENT ANALYSIS

Loads resulting from fluid transients (such as opening and closing of valves, startup and coast down of pumps) should be considered if they are anticipated occurrences from normal operation of the system.

Fluid transients resulting from Design Basis Accidents should be identified in the project design documents, and analyzed accordingly.

Unanticipated transients (transients which do not result from normal operation of the system) need not be analyzed, and should be precluded by proper operating, maintenance and testing procedures.

WIND DESIGN

Wind design shall be considered for outdoor piping. Wind loads should be applied as a uniformly distributed load of magnitude and direction defined in the project Functional Design Criteria or Design Documents. Refer to [ASCE 7-95](#) for reference methods.

PIPING SYSTEM QUALIFICATION

The requirements of the applicable code shall apply, for the load combinations defined with the following additions and clarifications:

For B31.1 piping, and B31.3 piping analyzed to B31.1 rules, the allowable stress for faulted loading should be the minimum of $3S_h$ or $2S_y$.

Higher allowables may be considered based on detailed analysis per ASME III NB-3200.

Where stress indices and stress intensification factors are not defined in the Code, they must be justified on a case basis.

Faulted seismic anchor motion amplitudes should be included in the qualification of piping faulted primary stress. Alternatively, half the faulted seismic anchor motion amplitude may be added to the thermal stress range.

The compliance of piping stress to code allowables insures that the piping cross section and pressure boundary remain intact. In addition, requirements for equipment and component operability or integrity need to apply.

Higher allowables or alternate evaluation methods may be used for piping systems that only need to retain structural integrity (not fall).

QUALIFICATION OF IN-LINE EQUIPMENT AND COMPONENTS**QUALIFICATION OF ACTIVE VALVES AND IN-LINE COMPONENTS**

The acceleration of active valve/s (i.e., valves which are required to change state during or after the DBE, excluding check valves) and in-line components should be limited to values provided by the vendor. When allowable valve and component accelerations are not provided, a limit of 3g resultant horizontal and 3g (including 1g from deadweight) vertical should apply at the center of gravity of the actuator.

Section REF References

Rev. 0, 9/17/2014

REF-3 ASME B31.3 Process Piping Guide

The nozzle loads on active valves and in-line components should be limited to values specified by the vendor. Where allowable nozzle loads are not specified, the pipe stress at the valve and component nozzle considering pipe cross-section properties should meet the pipe stress allowables.

The rules of the [DOE-EH-0545](#) may be used for verification of seismic adequacy of existing (installed) piping mounted components for existing systems.

FLANGE QUALIFICATION

Flanges should be qualified using the methods specified in B31.1 or B31.3.

EQUIPMENT NOZZLE LOADS

The nozzle loads on equipment should be limited to values specified by the vendor or derived by analysis. Where allowable nozzle loads are not specified, the pipe stress at the equipment nozzle shall meet the pipe stress allowables. Where no vendor limits are specified, the total stress (primary plus secondary) shall not exceed $0.3S_n$ at the nozzle of rotating equipment unless justified on a case basis.

PROTECTION AGAINST SEISMIC INTERACTIONS

The seismic qualification of a piping system requires its protection from credible and significant interactions, and spatial interactions (falling objects or impact interference with adjacent structures).

EXPANSION JOINTS

Expansion joints should be qualified by comparison of calculated displacements to vendor allowables or by analysis to the rules of the Expansion Joint Manufacturers Association as specified in the applicable ASME B31.1 or B31.3.

APPENDIX J – FILLET WELD SIZES

The following table provides a convenient reference of the sizes of fillet weld that are required by both the ASME B31.1 and B31.3 piping codes.

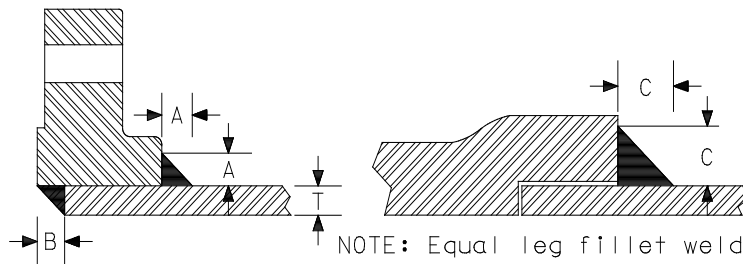

NPS	Sched	T	1.09 T	1.4 T	SO & SW FLANGE			FITTINGS
					A(B31.1)	A(B31.3)	B	C
1/8	10s	0.049	0.053	0.069				1/8
	40	0.068	0.074	0.095				1/8
	80	0.095	0.104	0.133				1/8
1/4	10s	0.065	0.071	0.091	1/8	1/8		1/8
	40	0.088	0.096	0.123	1/8	1/8		1/8
	80	0.119	0.130	0.167	3/16	3/16		3/16
3/8	10s	0.065	0.071	0.091	1/8	1/8		1/8
	40	0.091	0.099	0.127	1/8	3/16		1/8
	80	0.126	0.137	0.176	3/16	3/16		3/16
1/2	5s	0.065	0.071	0.091	1/8	1/8	T	1/8
	10s	0.083	0.090	0.116	1/8	1/8	T	1/8
	40	0.109	0.119	0.153	1/8	3/16	T	1/8
	80	0.147	0.160	0.206	3/16	1/4	T	3/16
	160	0.188	0.205	0.263	1/4	5/16	T	1/4
	xx	0.294	0.320	0.412	3/8	7/16	1/4	3/8
3/4	5s	0.065	0.071	0.091	1/8	1/8	T	1/8
	10s	0.083	0.090	0.116	1/8	1/8	T	1/8
	40	0.113	0.123	0.158	1/8	3/16	T	1/8
	80	0.154	0.168	0.216	3/16	1/4	T	3/16
	160	0.219	0.239	0.307	1/4	5/16	T	1/4
	xx	0.308	0.336	0.431	3/8	7/16	1/4	3/8
1	5s	0.065	0.071	0.091	1/8	1/8	T	1/8
	10s	0.109	0.119	0.153	1/8	3/16	T	1/8
	40	0.133	0.145	0.186	3/16	1/4	T	3/16
	80	0.179	0.195	0.251	1/4	5/16	T	1/4
	160	0.250	0.273	0.350	5/16	3/8	1/4	5/16
	xx	0.358	0.390	0.501	7/16	9/16	1/4	7/16
1 1/4	5s	0.065	0.071	0.091	1/8	1/8	T	1/8
	10s	0.109	0.119	0.153	1/8	3/16	T	1/8
	40	0.140	0.153	0.196	3/16	1/4	T	3/16
	80	0.191	0.208	0.267	1/4	5/16	T	1/4
	160	0.250	0.273	0.350	5/16	3/8	1/4	5/16
	xx	0.382	0.416	0.535	7/16	9/16	1/4	7/16
1 1/2	5s	0.065	0.071	0.091	1/8	1/8	T	1/8
	10s	0.109	0.119	0.153	1/8	3/16	T	1/8
	40	0.145	0.158	0.203	3/16	1/4	T	3/16
	80	0.200	0.218	0.280	1/4	5/16	T	1/4

Section REF References

Rev. 0, 9/17/2014

REF-3 ASME B31.3 Process Piping Guide

NPS	Sched	T	1.09 T	1.4 T	SO & SW FLANGE			FITTINGS
					A(B31.1)	A(B31.3)	B	C
	160	0.281	0.306	0.393	5/16	7/16	¼	5/16
	xx	0.400	0.436	0.560	7/16	9/16	¼	7/16
2	5s	0.065	0.071	0.091	1/8	1/8	T	1/8
	10s	0.109	0.119	0.153	1/8	3/16	T	1/8
	40	0.154	0.168	0.216	3/16	¼	T	3/16
	80	0.218	0.238	0.305	¼	5/16	T	¼
	160	0.344	0.375	0.482	3/8	½	¼	3/8
	xx	0.436	0.475	0.610	½	5/8	¼	½
2 ½	5s	0.083	0.090	0.116	1/8	1/8	T	1/8
	10s	0.120	0.131	0.168	3/16	3/16	T	3/16
	40	0.203	0.221	0.284	¼	5/16	T	¼
	80	0.276	0.301	0.386	5/16	7/16	¼	5/16
	160	0.375	0.409	0.525	7/16	9/16	¼	7/16
	xx	0.552	0.602	0.773	5/8	13/16	¼	5/8
3	5s	0.083	0.090	0.116	1/8	1/8	T	1/8
	10s	0.120	0.131	0.168	3/16	3/16	T	3/16
	40	0.216	0.235	0.302	¼	5/16	T	¼
	80	0.300	0.327	0.420	3/8	7/16	¼	3/8
	160	0.438	0.477	0.613	½	5/8	¼	½
	xx	0.600	0.654	0.840	11/16	7/8	¼	11/16
3 ½	5s	0.083	0.090	0.116	1/8	1/8	T	1/8
	10s	0.120	0.131	0.168	3/16	3/16	T	3/16
	40	0.226	0.246	0.316	¼	5/16	T	¼
	80	0.318	0.347	0.445	1/8	½	¼	3/8
4	5s	0.083	0.090	0.116	1/8	1/8	T	1/8
	10s	0.120	0.131	0.168	3/16	3/16	T	3/16
	40	0.237	0.258	0.332	5/16	3/8	T	5/16
	80	0.337	0.367	0.472	3/8	½	¼	3/8
	120	0.438	0.477	0.613	½	5/8	¼	½
	160	0.531	0.579	0.743	5/8	¾	¼	5/8
	xx	0.674	0.735	0.944	¾	1	¼	¾
5	5s	0.109	0.119	0.153	1/8	3/16	T	NA
	10s	0.134	0.146	0.188	3/16	3/16	T	
	40	0.258	0.281	0.361	5/16	3/8	¼	
	80	0.375	0.409	0.525	7/16	9/16	¼	
	120	0.500	0.545	0.700	9/16	¾	¼	
	160	0.625	0.681	0.875	11/16	7/8	¼	
	xx	0.750	0.818	1.050	7/8	1 1/16	¼	
6	5s	0.109	0.119	0.153	1/8	3/16	T	NA
	10s	0.134	0.146	0.188	3/16	3/16	T	
	40	0.280	0.305	0.392	5/16	7/16	¼	
	80	0.432	0.471	0.605	½	5/8	¼	
	120	0.562	0.613	0.787	5/8	13/16	¼	
	160	0.719	0.784	1.007	13/16	1 1/16	¼	
	xx	0.864	0.942	1.210	1	1 ¼	¼	
8	5s	0.109	0.119	0.153	1/8	3/16	T	NA
	10s	0.148	0.161	0.207	1/8	¼	T	
	20	0.250	0.273	0.350	3/16	3/8	¼	
	30	0.277	0.302	0.388	5/16	7/16	¼	
	40	0.322	0.351	0.451	3/8	½	¼	
	60	0.406	0.443	0.568	½	5/8	¼	
	80	0.500	0.545	0.700	9/16	¾	¼	
	100	0.594	0.647	0.832	11/16	7/8	¼	
	120	0.719	0.784	1.007	13/16	1 1/16	¼	
	140	0.812	0.885	1.137	15/16	1 3/16	¼	
	160	0.906	0.988	1.268	1	1 5/16	¼	
	xx	0.875	0.954	1.225	1	1 ¼	¼	

REF-3 ASME B31.3 Process Piping Guide

NPS	Sched	T	1.09 T	1.4 T	SO & SW FLANGE			FITTINGS
					A(B31.1)	A(B31.3)	B	C
10	5s	0.134	0.146	0.188	1/8	3/16	T	NA
	10s	0.165	0.180	0.231	3/16	¼	T	
	20	0.250	0.273	0.350	5/16	3/8	¼	
	30	0.307	0.335	0.430	3/8	7/16	¼	NA
	40	0.365	0.398	0.511	7/16	9/16	¼	
	60	0.500	0.545	0.700	9/16	¾	¼	
	80	0.594	0.647	0.832	11/16	7/8	¼	
	80s	0.500	0.545	0.700	9/16	¾	¼	
	100	0.719	0.784	1.007	13/16	1 1/16	¼	
	120	0.844	0.920	1.182	15/16	1 3/16	¼	
	140	1.000	1.090	1.400	1 1/16	1 7/16	¼	
160	1.125	1.226	1.575	1 ¼	1 5/8	¼		
xx	1.000	1.090	1.400	1 1/8	1 7/16	¼		
12	5s	0.156	0.170	0.218	3/16	¼	T	NA
	10s	0.180	0.196	0.252	¼	5/16	T	
	20	0.250	0.273	0.350	5/16	3/8	¼	
	30	0.250	0.360	0.462	3/8	½	¼	
	40	0.330	0.443	0.568	½	5/8	¼	
	40s	0.406	0.409	0.525	7/16	9/16	¼	
	STD	0.375	0.409	0.525	7/16	9/16	¼	
	60	0.562	0.613	0.787	5/8	13/16	¼	
	80	0.688	0.750	0.963	¾	1	¼	
	80s	0.500	0.545	0.700	9/16	¾	¼	
	100	0.844	0.920	1.182	15/16	1 3/16	¼	
	120	1.000	1.090	1.400	1 1/8	1 7/16	¼	
	140	1.125	1.226	1.575	1 ¼	1 5/8	¼	
	160	1.312	1.430	1.837	1 7/16	1 7/8	¼	
x	0.500	0.545	0.700	9/16	¾	¼		
xx	1.000	1.090	1.400	1 1/8	7/16	¼		
14	5s	0.156	0.170	0.218	3/16	¼	T	NA
	10	0.250	0.273	0.350	5/16	3/8	¼	
	10s	0.188	0.205	0.263	¼	5/16	T	
	20	0.312	0.340	0.437	3/8	7/16	¼	
	30	0.375	0.409	0.525	7/16	9/16	¼	
	40	0.438	0.477	0.613	½	5/8	¼	
	40s	0.375	0.409	0.525	7/16	9/16	¼	
	60	0.594	0.647	0.832	11/16	7/8	¼	
	80	0.750	0.818	1.050	7/8	1 1/16	¼	
	80s	0.500	0.545	0.700	9/16	¾	¼	
	100	0.938	1.022	1.313	1 1/16	1 5/16	¼	
	120	1.094	1.192	1.532	1 ¼	1 9/16	¼	
	140	1.250	1.363	1.750	1 3/8	1 ¾	¼	
	160	1.406	1.533	1.968	1 9/16	2	¼	
x	0.500	0.545	0.700	9/16	¾	¼		
16	5s	0.165	0.180	0.231	3/16	¼	T	NA
	10	0.250	0.273	0.350	5/16	3/8	¼	
	10s	0.188	0.205	0.263	¼	5/16	T	
	20	0.312	0.340	0.437	3/8	7/16	¼	
	30	0.375	0.409	0.525	7/16	9/16	¼	
	40	0.500	0.545	0.700	9/16	¾	¼	
	40s	0.375	0.409	0.525	7/16	9/16	¼	
	60	0.656	0.715	0.918	¾	15/16	¼	
	80	0.844	0.920	1.182	15/16	1 3/16	¼	
	80s	0.500	0.545	0.700	9/16	¾	¼	
	100	1.031	1.124	1.443	1 1/8	1 ½	¼	
	120	1.219	1.329	1.707	1 3/8	1 ¾	¼	
	140	1.438	1.567	2.013	1 9/16	2 1/16	¼	

REF-3 ASME B31.3 Process Piping Guide

NPS	Sched	T	1.09 T	1.4 T	SO & SW FLANGE			FITTINGS
					A(B31.1)	A(B31.3)	B	C
	160	1.594	1.737	2.232	1 3/4	2 1/4	1/4	
18	5s	0.165	0.180	0.231	3/16	1/4	T	NA
	10	0.250	0.273	0.350	5/16	3/8	1/4	
	10s	0.188	0.205	0.263	1/4	5/16	T	
	20	0.312	0.340	0.437	3/8	7/16	1/4	
18	STD	0.375	0.409	0.525	7/16	9/16	1/4	NA
	30	0.438	0.477	0.613	1/2	5/8	1/4	
	40	0.562	0.613	0.787	5/8	13/16	1/4	
	40s	0.375	0.409	0.525	7/16	9/16	1/4	
	60	0.750	0.818	1.050	7/8	1 1/16	1/4	
	80	0.938	1.022	1.313	1 1/16	1 3/8	1/4	
	80s	0.500	0.545	0.700	9/16	3/4	1/4	
	100	1.156	1.260	1.618	1 5/16	1 5/8	1/4	
	120	1.375	1.499	1.925	1 1/2	1 15/16	1/4	
	140	1.562	1.703	2.187	1 3/4	2 3/16	1/4	
160	1.781	1.941	2.493	2	2 1/2	1/4		
	x	0.500	0.545	0.700	9/16	3/4	1/4	
20	5s	0.188	0.205	0.263	1/4	5/16	T	NA
	10	0.250	0.273	0.350	5/16	3/8	1/4	
	10s	0.218	0.238	0.305	1/4	5/16	T	
	20	0.375	0.409	0.525	7/16	9/16	1/4	
	30	0.500	0.545	0.700	9/16	3/4	1/4	
	40	0.594	0.647	0.832	11/16	7/8	1/4	
	40s	0.375	0.409	0.525	7/16	9/16	1/4	
	60	0.812	0.885	1.137	15/16	1 3/16	1/4	
	80	1.031	1.124	1.443	1 1/8	1 1/2	1/4	
	80s	0.500	0.545	0.700	9/16	3/4	1/4	
	100	1.281	1.396	1.793	1 7/16	1 13/16	1/4	
	120	1.500	1.635	2.100	1 11/16	2 1/8	1/4	
140	1.750	1.908	2.450	1 15/16	2 1/2	1/4		
160	1.969	2.146	2.757	2 13/16	2 13/16	1/4		
22	5s	0.188	0.205	0.263	1/4	5/16	T	NA
	10	0.250	0.273	0.350	5/16	3/8	1/4	
	10s	0.218	0.238	0.305	5/16	5/16	T	
	20	0.375	0.409	0.525	7/16	9/16	1/4	
	30	0.500	0.545	0.700	9/16	3/4	1/4	
	40s	0.375	0.409	0.525	7/16	9/16	1/4	
	60	0.875	0.954	1.225	1	1 1/4	1/4	
	80	1.125	1.226	1.575	1 1/4	1 5/8	1/4	
	80s	0.500	0.545	0.700	9/16	3/4	1/4	
	100	1.375	1.499	1.925	1 1/2	1 15/16	1/4	
	120	1.625	1.771	2.275	1 13/16	2 5/16	1/4	
	140	1.975	2.153	2.765	2 3/16	2 13/16	1/4	
160	2.125	2.316	2.975	2 3/8	3	1/4		
24	5s	0.218	0.238	0.305	5/16	5/16	T	NA
	10	0.250	0.273	0.350	5/16	3/8	1/4	
	10s	0.250	0.273	0.350	5/16	3/8	1/4	
	20	0.375	0.409	0.525	7/16	9/16	1/4	
	30	0.562	0.613	0.787	5/8	13/16	1/4	
	40	0.688	0.750	0.968	3/4	1	1/4	
	40s	0.375	0.409	0.525	7/16	9/16	1/4	
	60	0.969	1.056	1.357	1 1/16	1 3/8	1/4	
	80	1.219	1.329	1.707	1 3/8	1 3/4	1/4	
	80s	0.500	0.545	0.700	9/16	3/4	1/4	
	100	1.531	1.669	2.143	1 11/16	2 3/16	1/4	
	120	1.812	1.975	2.537	2	2 9/16	1/4	
140	2.062	2.248	2.887	2 1/4	2 15/16	1/4		

Section REF References

Rev. 0, 9/17/2014

REF-3 ASME B31.3 Process Piping Guide

NPS	Sched	T	1.09 T	1.4 T	SO & SW FLANGE			FITTINGS
					A(B31.1)	A(B31.3)	B	C
	160	2.344	2.555	3.282	2 9/16	3 5/16	1/4	
	x	0.500	0.545	0.700	9/16	3/4	1/4	
30	10	0.312	0.340	0.437	3/8	7/16	1/4	NA
	STD	0.375	0.409	0.525	7/16	9/16	1/4	
	20	0.500	0.545	0.700	9/16	3/4	1/4	
	30	0.625	0.681	0.875	11/16	7/8	1/4	

NOTES:

1. The A, B, and C dimensions are the minimum fractional dimensions that satisfy the Codes. A(B31.1) is 1.09T raised to next higher 1/16". A(B31.3) is 1.4T raised to next higher 1/16".
2. T is defined as the nominal pipe wall thickness.
3. The A dimension is the lesser of A or the thickness of the hub.
4. The C dimension is the lesser of C as listed herein or the thickness of the socket wall.
5. This table is not applicable when pipe is purchased to other than schedule, standard, XS, and XXS wall thicknesses.

APPENDIX K – CLEANING CARBON AND STAINLESS STEEL PIPE**GENERAL**

The various types of contamination and the methods suitable for their removal are listed in Table 1. Reference ASTM A380 for more information on cleaning and descaling stainless steels.

Information on the types of contamination that must be removed shall be obtained from project specifications or consultation with the appropriate design authority.

The amount of free iron contamination that can be tolerated and the extent of the surface area to be tested shall be specified by the appropriate Design Authority.

INSPECTION

All pipe cleaned in accordance with this Appendix should be inspected to determine the effectiveness of the cleaning method used.

Cleaning methods that are employed solely for the removal of dirt, paint, metal chips, filings, flux, slag, weld spatter, scale, rust, or other types of contamination that are easily seen should be visually inspected with the unaided eye to ensure that the contaminants have been removed. This inspection should include interior surfaces.

When cleaning methods are used for the purpose of removing grease, oil, waxes, or other contaminants that may exist as a thin film, items should be wiped with a clean, white, solvent dampened cloth to ensure that the contamination has been removed.

Removal of free iron contamination should be confirmed through the use of a ferroxyl test. The ferroxyl test is highly sensitive and is required only when traces of free iron or iron oxide would be unacceptable. 400 Series stainless steels may contain a gray smut after acid treatments. This smut must be removed by a thorough washing using water, detergent, and scrub brushes before ferroxyl testing, or the test will be positive.

SAFETY

Use of compressed air creates a hazard from flying particles. Use proper eye protection.

Mechanical cleaning with power tools using wire brushes, grinding wheels, and sanding attachments presents hazards from flying particles and rotating shafts. Use protective clothing and eye protection, and ensure that clothing will not become entangled in the equipment.

Abrasive blast cleaning presents hazards to personnel. Protective clothing, eye protection, and in some cases respiratory protection are required for safe operation.

Use of acids and cleaning agents presents hazards to the environment and personnel. Environmental restrictions on the use and disposal of cleaning solutions must be adhered to. Face shields, rubber gloves, protective clothing, and respiratory protection may be required when using corrosive chemicals and proprietary cleaners. Consideration should be given to the proximity of safety showers and eyewash stations.

CLEANING METHODS**Method A-1, Water Flush.**

Flush pipe with clean water, on stainless steel use only water having a chloride content less than 50 ppm for the final flush. (Note: domestic water generally contains less than 2 ppm chlorides).

Dry to conform to system requirements.

Section REF References

Rev. 0, 9/17/2014

REF-3 ASME B31.3 Process Piping Guide

Method A-2, Steam or Air Blow

Blow pipe with clean, dry, compressed air or steam. Use sufficient volume of air to create a high velocity stream in the pipe. If air is supplied from compressors, they shall be equipped with moisture separators, oil separators, traps, and/or filters, as required to ensure that the air is clean and dry.

Method B, Steam Cleaning.

Use steam at pressures from 50 to 75 psi in conjunction with cleaning agents such as emulsions, detergents, solvents, and alkalis. Proprietary cleaners may contain harmful ingredients such as chlorides or sulfur, which may adversely affect the material to be cleaned, especially in the case of stainless steel. The manufacturer of the cleaning agent should be contacted prior to its use when any doubt exists.

Drain pipe and flush with clean water, use chloride free water on stainless steel. (See method A-1)

Blow dry with clean, dry, compressed air. (See method A-2)

Method C-1, Blast Cleaning

Clean, previously unused glass beads, iron free silica, walnut shells, or alumina sand are required for abrasive blasting of stainless steel pipe. For carbon steel pipe use sand, steel shot, or steel grit. Blast clean inside and outside surfaces as required.

Use clean, dry, compressed air. (See method A-2)

Follow with procedure A-1 or A-2.

Method C-2, Mechanical Cleaning

Wire brushing, sanding, and grinding are suitable methods for localized removal of scale and spatter left by welding. Stainless steel wire brushes are required for use on stainless steel pipe. Grinding wheels, wire brushes, and sanding materials containing iron, iron oxide, or zinc, or those previously used on other metals, shall not be used to clean stainless steel pipe.

Method D-1, Dehydration of Carbon Steel Pipe for Low Temperature Service Using Nitrogen

This procedure is recommended for removal of small amounts of moisture that may exist in a nominally dry system.

Evacuate system to an absolute pressure of 5 mm of mercury or less. If it is necessary to dehydrate an outdoor system when the temperature is less than 36° F, special precautions must be taken to ensure proper dehydration. These may include sweeping with dry gas, circulating warm water or brine, blanketing of equipment, or using electric resistance heaters.

Difficulty in achieving the required vacuum may be due to presence of excess moisture in the system, leakage of air into the system, a faulty or inadequate vacuum pump, or the presence of absorbed refrigerant or moisture in the vacuum pump oil.

If a leak is the suspected cause of insufficient vacuum, perform a leak test of the required sensitivity to locate the leak(s) and repair.

When the required vacuum is reached, isolate the vacuum pump and let the system stand for a minimum of 4 hours. A pressure rise of not more than .4mm of mercury during this period will indicate sufficient dehydration. After the system is completely dehydrated, charge it with an inert dry gas suitable to the use of the line. Build up pressure to 50% of design pressure, tag and seal the system until start-up.

Method D-2, Dehydration of Carbon Steel Pipe for Low Temperature Service by the Alcohol Method

This procedure is recommended where small amounts of water are suspected in the system, such as in pockets, fittings, and valves.

Section REF References

Rev. 0, 9/17/2014

REF-3 ASME B31.3 Process Piping Guide

Drain and dry the system with clean, dry, compressed air. Use resistance testing to ensure that the system is completely statically grounded.

Fill the system with alcohol (methanol preferred). Make sure all high spots are vented, and the system is completely wetted with alcohol, then completely drain the alcohol from the system.

Pull a vacuum on the system, test and fill with inert gas per procedure D-1 above.

Method E-1, Sulfuric Acid Cleaning of Carbon Steel Pipe

Acid cleaning is not effective for removal of greases, oils, and waxes. Surfaces should be pre-cleaned using method B.

Pickle with a solution containing 5 to 10 weight percent inhibited sulfuric acid until all scale and rust are removed (pickling times of 15 to 20 minutes are normal). Heat and maintain pickling solution between 160°F and 180°F.

Pump solution through pipe or immerse in a pickling tank. Immediately flush with clean water followed by a hot water rinse containing one half ounce per gallon of sodium carbonate (Na_2CO_3) or tri-sodium phosphate (TSP -- Na_3PO_4).

Flush with rust inhibitor consisting of 0.5% sodium nitrite (NaNO_2), 0.25% disodium phosphate (Na_2HPO_4) and 0.25% monosodium phosphate (NaH_2PO_4). Dry to conform to system requirements.

Methods F-1 Through 13, Use of Acid for Descaling or Cleaning Stainless Steel**General**

Descaling is the removal of heavy, tightly adherent oxide films resulting from hot-forming, heat treatment, welding and other high-temperature operations. Descaling methods are outlined in Table 2, Part I. Cleaning is the removal of surface contaminants to enhance appearance and corrosion resistance, and to prevent the contamination of product. Cleaning methods are outlined in Table 2, Parts II and III. Passivation is generally not needed except in cases where the material will not be exposed to air or other oxygen containing environment long enough to establish a passive film. Cleaning and Passivation methods are listed in Table 2, Part III.

Precautions

Exposure to the descaling solutions in Table 2, Part I, for more than 30 minutes must be avoided. Drain and rinse the item and re-apply the treatment if required. Intermittent scrubbing with a stainless steel or fiber brush may facilitate the removal of heavy scale.

Use of nitric-hydrofluoric acid solutions on stainless steel may produce intergranular attack in cases where the metal has been sensitized by welding or improper heat treatment. This can lead to stress corrosion cracking under service conditions, and is not recommended. In the case of weldments, only those of the low carbon and stabilized grades may be safely treated with these solutions.

Hardenable 400 Series, managing, and precipitation hardening alloys in the hardened condition are subject to intergranular attack and hydrogen embrittlement when exposed to acids. Use mechanical or other chemical methods whenever possible. If acid treatment is unavoidable, parts shall be heated to 250 - 300°F for 24 hours to drive off hydrogen.

Severe pitting may result from prolonged exposure to acid solutions if the solution becomes depleted or if the concentration of metallic salts becomes too high as a result of prolonged use of the solution. For the methods in Table 2, part I, limit dissolved iron concentration to 5 weight %. Limit the concentration of dissolved iron to 2 weight % for all other methods listed in Table 2.

Section REF References

Rev. 0, 9/17/2014

REF-3 ASME B31.3 Process Piping Guide

Method for Using Acid Solutions to Clean and Descale Stainless Steel

Acid treatments are not effective for removal of greases, oils, and waxes. Surfaces should be pre-cleaned using procedure B if these contaminants are present.

Select appropriate treatment from Table 2. Total immersion is the preferred method of application, but the acid solution may be circulated around or through the item, or the item may be swabbed or sprayed so that all surfaces receive the required treatment.

All items exposed to acid solutions must be thoroughly rinsed at the completion of the treatment. To minimize staining, the item must not be allowed to dry between steps. If necessary, a neutralizer solution may be used, followed by a final hot water rinse. Final rinse water shall contain less than 50 ppm chlorides.

Items are to be thoroughly dried after final rinsing.

References

- 1) KIE Freon Refrigeration System, Leak Testing, Dehydration and Charging
- 2) [Steel Structures Painting Council:](#)
 Systems and Specifications, Steel Structures Painting Manual, Volume 2
 Good Painting Practice, Volume 1, Chapter 3.2 Pickling Steel Surfaces.

Tables

Table 1 - Contamination Types and Removal Procedures

Table 2 - Cleaning and Descaling Stainless Steel

TABLE 1 - CONTAMINATION TYPES AND REMOVAL PROCEDURES	
Types of Contamination	Removal Procedures
Dirt, Metal Chips, and Filings	A-1, A-2, B
Oil, Paint, Grease Wax, Varnish	B
Moisture	D-1, D-2
Weld Spatter, Rust, Scale, Slag, Free Iron	C-1, C-2, E-1, E-2, F-1 through 13

Section REF References

Rev. 0, 9/17/2014

REF-3 ASME B31.3 Process Piping Guide

TABLE 2 -- CLEANING AND DESCALING STAINLESS STEEL					
Alloy	Condition	Treatment			
		Method	Solution Volume% ^B	Temperature P	Time, Minutes
Part I Acid Descaling of Stainless Steel					
200, 300, and 400 Series, precipitation hardening and maraging alloys (except free machining alloys). ^A	fully annealed only	F-1	H ₂ SO ₄ , 8-11% Follow by method F-4 or F-6	150-180	5-45 max ^D
200 and 300 Series, 400 Series containing Cr 16% or more, precipitation-hardening alloys (except free machining alloys). ^A	fully annealed only	F-2	HNO ₃ , 15-25% plus HF 1-8% ^F	70-140 max	6-30 ^D
All free machining alloys and 400 Series containing less than Cr 16%. ^A	fully annealed only	F-3	HNO ₃ 10-15% plus HF 0.5-1.5% ^F	70 (up to 140 with caution)	6-30 ^D
Part II Cleaning With Nitric-Hydrofluoric Acid					
200 and 300 Series, 400 Series containing 16% Cr or more, and precipitation hardening alloys (except free machining alloys).	fully annealed only	F-4	HNO ₃ , 6-25% plus HF 0.5-8% ^{E,F}	70-140	as necessary
Free machining alloys, maraging alloys, and 400 Series containing less than Cr 16%.	fully annealed only	F-5	HNO ₃ , 10% plus HF 0.5-1.5% ^{E,F}	70 (up to 140 with caution)	1-2
Part III Cleaning and Passivation with Nitric Acid Solution					
200 and 300 Series, 400 Series, precipitation hardening and maraging alloys containing 16% Cr or more (except free-machining alloys). ^G	annealed, cold rolled or work hardened, with dull or non-reflective surfaces	F-6	HNO ₃ , 20-50%	120-160 70-100	10-30 30-60 ^F
	annealed, cold rolled or work hardened, with bright machined or polished surfaces	F-7	HNO ₃ , 20-40% plus Na ₂ Cr ₂ O ₇ , 2H ₂ O, 2-6 weight %	120-155 70-100	10-30 30-60 ^F
400 Series, maraging and precipitation hardening alloys containing less than Cr 16%, high carbon straight Cr alloys (except free machining alloys). ^G	annealed or hardened with dull or non-reflective surface	F-8	HNO ₃ , 20-50%	110-130 70-100	15-30 60
	annealed or hardened with bright machined or polished surfaces	F-9	HNO ₃ , 20-25% plus Na ₂ Cr ₂ O ₇ , 2H ₂ O, 2-6 weight %	120-130 70-100	20-30 30-60
200, 300, 400 Series free-machining alloys. ^G	annealed or hardened with bright machined or polished surfaces	F-10 ^I	HNO ₃ , 20-50% plus Na ₂ Cr ₂ O ₇ , 2H ₂ O, 2-6 weight %	70-120	25-30
		F-11 ^H	HNO ₃ , 1-2% plus Na ₂ Cr ₂ O ₇ , 2H ₂ O, 1-5 weight %	120-140	10
		F-12	HNO ₃ , 12% plus CuSO ₄ · 5H ₂ O, 4 weight %	120-140	10
Special free machining 400 Series alloys with more than Mn 1.25%, or more than 0.40%. ^G	annealed or hardened with bright machined or polished surfaces	F-13	HNO ₃ , 40-60% plus Na ₂ Cr ₂ O ₇ , 2H ₂ O, 2-6 weight %	110-130	20-30

Notes:

^AThis is also applicable to the cast grades equivalent to the families of wrought materials listed.

^BSolution prepared from reagents of the following weight %: H₂SO₄ 98, HNO₃, 67, HF, 70.

^CTight scale may be removed by a dip in this solution for a few minutes, followed by a water rinse and nitric-hydrofluoric treatment as noted.

^DMinimum contact times necessary to obtain the desired surfaces should be used in order to prevent over pickling. Tests should be made to establish correct procedure for specific applications.

^EFor reasons of convenience and handling safety, commercial formulations containing fluoride salts may be used in place of HF for preparing nitric-hydrofluoric acid solutions.

^FAfter pickling and water rinsing, an aqueous caustic permanganate solution containing NaOH, 10 weight%, and KMnO₄, 4 weight %, 160-180 F, 5-60 minutes, may be used as a final dip for removal of smut, followed by a thorough rinsing and drying.

^GAs an option, all 400 Series ferritic or martensitic parts may receive additional treatment as follows: within one hour after the water rinse following the specified passivation treatment, all parts shall be immersed in an aqueous solution containing 4 to 6 weight % Na₂Cr₂O₇•2H₂O at 140 to 160°F for 30 minutes. This immersion shall be followed by a thorough rinsing with clean water, and thoroughly dried.

^HShorter times may be acceptable where established by test.

^IHigh carbon and free machining alloys may be subject to etching or discoloration, use higher acid concentrations to minimize this.

If fresh attack (clouding on stainless steel surface) occurs, a fresh (clean) passivating solution or a higher HNO concentration will usually eliminate it.

APPENDIX L – BURIED PROCESS PIPE

SPECIAL CONSIDERATIONS FOR BURIED PROCESS PIPE

Engineering and Construction must consider the following factors to assure safe operation of a buried piping system:

- A. The selection of the proper pipe material, coating and lining and their compatibility with soil and fluid (input from Materials Engineer, Vendor and past practice).
- B. The judicious routing of the pipe to minimize natural risks such as soil settlement, flood or frost (input from Geotechnical Engineer).
- C. The structural design of the piping system (further discussed in this Appendix).
- D. The proper trench preparation and pipe laying (further discussed in this Appendix).
- E. The joining method and the quality of fabrication, examination and pressure testing which must comply with ASME B31.3 if the piping is part of a process system.
- F. The operation, periodic inspection and maintenance of the system.
- G. The use of line markers, sufficient ground cover and controls to avoid excavation damage.

CONSTRUCTION

The Fabrication, Examination and Inspection requirements of ASME B31.3 apply.

In addition, special provisions from Federal, State, local and Site requirements apply.

Non-Process Standards provide useful guidance; they include:

AWWA C206 Field Welding of Steel Water Pipe

AWWA Standard C600, Installation of Ductile-Iron Water Mains and their Appurtenances.

AWWA Manual M23 PVC Pipe - Design and Installation

AWWA Manual M11 Steel Pipe

ASCE Manual No 60 Gravity Sanitary Sewer Design and Construction

DESIGN OF BURIED PROCESS PIPE

LOADS ON BURIED PIPE

Soil and Surface loads consist of Internal Pressure, Restrained Thermal Growth or Contraction, Soil Settlement, Waterhammer, and Seismic (wave passage and differential movements) as applicable.

Design guidance for buried steel pipe may be found in “Design of Buried Steel Pipe,” (www.americanlifelinesalliance.org).

APPENDIX M – MITERED JOINTS

The equations provided below may be used to determine the maximum allowable internal pressure for mitered bends using the methods prescribed by ASME B31.3 paragraph 304.2.3. The designer performing these calculations should review the B31.3 Code to ensure he understands all the required details.

NOTE: Mathcad shells for performing these calculations for maximum internal pressure in single and multiple miter bends are available from the ESM Mechanical POC.

Step 1

Determine the total mechanical allowance (c) including the erosion and corrosion for the system in inches.

Step 2

Determine the material allowable stress (S) at the design temperature from Appendix A, B31.3 in psi.

Step 3

Determine the joint quality factor (E) from Appendix A, B31.3. For seamless pipe, E=1.

Step 4

Determine the outer diameter (D) and nominal wall thickness (T_{nom}) of the mitered pipe.

Step 5

Determine the geometric design configuration data: R₁ is the radius of curvature measured to the centerline of the pipe, θ is the angle of the mitered cut in degrees. See B31.3 Figure 304.2.3 for nomenclature. R₁ shall not be less than that calculated by equation M-1.

$$R_1 = \frac{A}{\tan \theta} + \frac{D}{2} \tag{M-1}$$

where A has the following empirical values:

(T-c), in.	A
≤0.5	1.0
0.5<(T-c)<0.88	2(T-c)
≥0.88	[2(T-c)/3]+1.17

Step 6

Calculate the minimum pipe wall thickness (nominal thickness minus mill tolerance).

$$T = 0.875T_{nom} \tag{M-2}$$

Step 7

Calculate the mean radius of the pipe using the nominal wall thickness.

$$r_2 = \frac{D - T_{nom}}{2} \tag{M-3}$$

Step 8

The design pressure for the mitered bend is determined using the equations provided below.

- a) For multiple mitered bend with θ ≤ 22.5 °, P_m is the minimum of the equations M-4 and M-5:

REF-3 ASME B31.3 Process Piping Guide

$$P_m = \frac{SE(T-c)}{r_2} \left(\frac{T-c}{(T-c) + 0.643 \tan\theta \sqrt{r_2(T-c)}} \right) \quad (M-4)$$

$$P_m = \frac{SE(T-c)}{r_2} \left(\frac{R_1 - r_2}{R_1 - 0.5r_2} \right) \quad (M-5)$$

- b) For single mitered bends with $\theta \leq 22.5^\circ$, use equation M-4. Otherwise, P_m is given by equation M-6.

$$P_m = \frac{SE(T-c)}{r_2} \left(\frac{T-c}{(T-c) + 1.25 \tan\theta \sqrt{r_2(T-c)}} \right) \quad (M-6)$$

Step 9

The miter pipe wall thickness (T) shall extend not less than a distance (M) from the insides crotch of the end miter welds. See B31.3 Figure 304.2.3. The length of the taper at the end of the miter pipe may be included in the distance (M). The required value of (M) is the larger of M-7 and M-8.

$$M = 2.5(r_2 T)^{0.5} \quad (M-7)$$

$$M = \tan\theta (R_1 - r_2) \quad (M-8)$$

APPENDIX N – BRANCH CONNECTIONS

The equations provided below may be used to determine the reinforcement requirements for a set-on branch connection using the methods prescribed by ASME B31.3 paragraph 304.3.3. The acceptable details that can be used with these equations are shown in figures 328.5.4D(1), (3), and (5). The equations below are based on no reinforcement pad at the branch connections. The equations are used to determine the requirements for additional reinforcement. The designer performing these calculations should review the B31.3 Code to ensure he understands all the required details. These equations are only applicable when the branch opening in the header pipe is a projection of the branch pipe inside diameter (i.e. the branch pipe is set on the header pipe).

NOTE: A Mathcad shell for calculations of reinforcement requirements for weld branch connections is available from the ESM Mechanical POC.

Step 1

Determine the total mechanical allowance (c) including the erosion and corrosion for the system in inches and the design pressure in psi.

Step 2

Determine the material allowable stress (S) at the design temperature from Appendix A, B31.3 in psi.

Step 3

Determine the joint quality factors (E_h and E_b) for the header and branch pipes from Appendix A, B31.3. For seamless pipe, E=1.

Step 4

Determine the outer diameter (D_h and D_b) and nominal wall thickness (T_{nom,h} and T_{nom,b}) of the header and branch pipe.

Step 5

Determine the smaller angle (β) between the branch and the header. See Figure 304.3.3 of B31.3.

Step 6

Calculate the required pressure design wall thicknesses using the equations N-1 and N-2.

$$t_h = \frac{PD_h}{2(SE + 0.4P)} \tag{N-1}$$

$$t_b = \frac{PD_b}{2(SE + 0.4P)} \tag{N-2}$$

Step 7

Calculate the required reinforcement area (A₁)

$$A_1 = t_h d_1 (2 - \sin \beta) \tag{N-3}$$

where

$$d_1 = [D_b - 2(T_b - c)] / \sin \beta \tag{N-4}$$

$$T_b = 0.875 T_{nom,b} \tag{N-5}$$

REF-3 ASME B31.3 Process Piping Guide

Step 8

Calculate the available reinforcement area (A_2) and (A_3)

$$A_2=(2d_2-d_1)(T_h-t_h-c) \tag{N-6}$$

$$A_3=2L_4(T_b-t_b-c)/\sin \beta \tag{N-7}$$

where

$$d_2=\max[d_1,(T_b-c)+(T_h-c)+d_1/2] \tag{N-8}$$

$$T_h=0.875T_{nom,h} \tag{N-9}$$

$$L_4=\min[2.5(T_h-c), 2.5(T_b-c)] \tag{N-10}$$

Step 9

Calculate the available reinforcement area (A_4). Area A_4 is the area of other metal provided by welds and properly attached reinforcement. See B31.3 paragraph 328.5.4 for minimum required weld sizes.

Step 10

Calculate the required reinforcement area (A_r). If A_r is positive, additional reinforcement is required. If A_r is less than or equal to zero, no additional reinforcement is required.

$$A_r= A_1 - (A_2 + A_3 + A_4) \tag{N-11}$$

APPENDIX O - SAFETY CLASS PIPING SYSTEMS**PURPOSE**

This appendix provides guidance for application of Code requirements to safety class items.

SCOPE

The information in this appendix applies to all piping and components designated as safety class.

GENERAL

- 1) New Safety Class (SC) piping shall comply with all the requirements of ASME B31.3 Category M Fluid Service unless restricted by other fluid service requirements.
- 2) Modifications and repairs to Safety Class piping shall comply with all the examination and testing requirements of ASME B31.3 Category M Fluid Service unless restricted by other fluid service requirements, except as permitted in Appendix P.
- 3) A sensitive leak test is not required for Safety Class systems unless the fluid service meets the requirements for a Category M Fluid Service or when imposed by the requirements of the Alternative Leak Test per B31.3 paragraph 345.1c.
- 4) When a facility has performed component level classification of piping systems only the specific components and portion of the system classified as Safety Class are required to meet the Category M requirements.

MATERIAL REQUIREMENTS

- 1) For safety class items, material traceability shall be maintained to the point of installation.

APPENDIX P – REPAIRS, MODIFICATIONS AND MAINTENANCE

PURPOSE

This appendix provides guidance for application of B31.3 requirements to repairs, modifications and maintenance of operating piping systems.

SCOPE

The information in this appendix applies to all piping systems for which ASME B31.3 applies.

GENERAL

Repairs and modifications to existing piping systems shall follow the requirements of the ASME B31.3 Code for materials, design, fabrication and examination. At the Design Authority's option, the three alternatives of Section A, B, or C below are acceptable to address the leak testing of repair and tie-in joints. All repair and modification joints other than the tie-in joints shall meet all the requirements of the Code. Non-welding maintenance shall follow the requirements of the ASME B31.3 Code for materials, design and fabrication. The examination and leak testing requirements for non-welding maintenance shall be as specified by the Design Authority.

Table 1 Requirement Matrix¹

	Modification	Repair	Non-Welding Maintenance
Design	B31.3	B31.3	B31.3
Materials	B31.3	B31.3	B31.3
Fabrication ²	B31.3	B31.3	B31.3
Examination	B31.3	B31.3	Design Authority ³
Leak Testing	B31.3	B31.3 ⁵	Design Authority ⁴

Notes:

- 1) This Table applies to all functional classifications (SC, SS, ML-1, ML-2, ML-3, etc.)
- 2) Fabrication refers to all shop or field fabrication, erection, assembly or disassembly related to new installations, modifications, repairs, or non-welding maintenance.
- 3) Unless restricted by other site or divisional requirements, the Design Authority is to determine the type and extent of examination. Performance of examinations shall be in accordance with site QA requirements.
- 4) Unless restricted by other site or divisional requirements, the Design Authority is to determine the type and extent of leak testing, if any, commensurate with the risk (likelihood and consequence) of leakage.
- 5) Also refer to sections A through C.

A REPAIR AND TIE-IN JOINTS THAT ARE CODE LEAK TESTED

Repair joints and tie-in joints in piping systems that are leak tested to the requirements of ASME B31.3 paragraph 345 "Testing" shall meet the following requirements.

- 1) Repair and tie-in joints shall be examined to the requirements of the Code.

413 When the repair joints and tie-in joints are not included in the random selection of joints to be examined, they shall be treated as a new and separate lot or lots of joints for examination purposes. Examination percentages of other joints (i.e. shop welds) included in the piping system repair or alteration may not be used to reduce the examination requirements of repair or tie-in joints.

B REPAIR JOINTS AND TIE-IN JOINTS THAT ARE IN-SERVICE LEAK TESTED

Repair joints and tie-in joints in piping systems that can not be Code tested but can be In- Service Leak tested to the requirements of paragraph 345.7, shall meet the following requirements. For repair and tie-in joints that can not be Code tested, the In-Service Leak Test is permitted for Normal and Category M fluid service.

REF-3 ASME B31.3 Process Piping Guide

- 1) All repair and tie-in joints shall be examined to the requirements of paragraph 335 "Assembly and Erection".
- 414 All butt-welded repair and tie-in joints shall be volumetrically examined to the requirements of ASME B31.3. All butt weld repair and tie-in joints shall be designed so they can be volumetrically examined, except as provided in 5.4.3.3. Welded branch connections used as tie-in joints shall meet the requirements of Figure 328.5.4E as being suitable for 100% radiography. For a normal fluid service the in-process examination alternative permitted in paragraph 341.4.1(b)(1) may be specified on a weld for weld basis if approved by engineering or the inspector. The in-process method shall be supplemented by appropriate nondestructive examination.
- 415 Socket welded joints are allowed as repair and tie-in welds on sizes up to and including 2 inch pipe. Slip-on flanges are allowed in all pipe sizes. All socket and slip-on repair and tie-in joints shall receive a PT or MT examination of the final completed welds.
- 416 An in-service leak test shall be performed on repair and tie-in joints per the requirements of ASME B31.3 paragraphs 345.7.1 - 345.7.3 except as noted in C below.

C REPAIR AND TIE-IN JOINTS THAT CAN NOT BE TESTED

Repair and tie-in joints in piping systems that can be neither Code nor In-Service leak tested shall meet the following requirements.

- 1) Repair and tie-in joints shall be full-penetration butt welds between straight sections of piping of equal diameter and thickness, axially aligned, and of equivalent materials.
- 417 Repair and tie-in joints shall be volumetrically examined to the requirements of ASME B31.3.
- 418 When mechanical joints are required to be used for maintenance and tie-in joints and cannot be leak tested, these joints shall be examined to the requirements of paragraph 335 "Assembly and Erection".

APPENDIX Q - APPLICATION OF ASME B31.3 TO RADIOACTIVE FLUIDS

The processing of radioactive fluids is performed in many facilities at LANL. No section of the B31 Code of Pressure Piping addresses radioactive fluids. When starting to address what code is applicable to radioactive fluids, many engineers return to the *ASME Boiler and Pressure Vessel Code, Section III, Rules for the Construction of Nuclear Power Plant Components*. The scope of Section III is directly applicable to nuclear power systems and does not apply to processing facilities. To address the application of radioactive fluids more directly, an inquiry was sent to the ASME B31 Committee. Interpretation 12-20 clarifying the use of radioactive fluids in processing facilities is provided below:

Question: In accordance with ASME B31.3-1993 Edition, may the owner apply B31.3 to piping containing radioactive fluids in a chemical plant?

Reply: Yes, see the Introduction which states that, "If no section of the code for pressure piping specifically covers the installation, the owner at his discretion may select any section determined to be generally applicable... It should be noted, however, that requirements supplementing the Code Section may be necessary to provide safe piping for the intended application".

Interpretation 12-20 stresses the need for requirements supplementing the Code for radioactive fluid services.

Based on Interpretation 12-20, two issues need to be addressed to apply ASME B31.3 to a radioactive fluid service. First, when will a fluid service be considered radioactive. Second, what are reasonable supplementary requirements to apply. The following definition and requirements are provided to support the use of ASME B31.3 for radioactive fluid processing. The owner and/or the designer may specify additional requirements that are deemed necessary to provide a safe piping system design.

The following definition of a radioactive fluid applies to activities addressed by this guide:

Radioactive Fluid – A fluid with sufficient radioactivity that leakage from a piping system could cause an area to exceed the contamination limits imposed by [P121, Att A, Table 14-2](#).

The following minimum additional requirement should be applied to systems containing radioactive fluids:

- 1) Radioactive fluids cannot be excluded from the scope of ASME B31.3.
- 2) Radioactive fluids cannot be classified as Category D fluid service.

Additional requirements supplementing the B31.3 Code may be required to ensure a safe design for radioactive fluid services.

APPENDIX R – DEFINITION OF ACRONYMS

AISC	American Institute of Steel Construction
API	American Petroleum Institute
ASME	American Society of Mechanical Engineering
AWS	American Welding Society
AWWA	American Water Works Association
B&PV	Boiler and Pressure Vessel
CLSM	Controlled Low Strength Material (flowable fill)
CMTR	Certified Mill Test Report
CPVC	Chlorinated Polyvinyl chloride
DOE	Department of Energy
DR	Design Ratio
EJMA	Expansion Joint Manufacturers Association
EPDM	Ethylene-propylene-diene monomer
ESM	LANL Engineering Standards Manual
IBC	International Building Code
IGSCC	Intergranular Stress-corrosion Cracking
IRHD	International Rubber Hardness Degree
LANL	Los Alamos National Laboratory
MSS	Manufacturers Standardization Society
NFPA	National Fire Protection Association
NMED	New Mexico Environment Department
NPH	Natural Hazard Phenomena
NPS	Nominal Pipe Size
OD	Outer Diameter
PE	Polyethylene
POC	Point-of-Contact
P-Spec or PS	Piping Specification
PTC	Performance Test Code
PTFE	Polytetrafluoroethylene
PVC	Polyvinyl chloride
RTFE	Reinforced Polytetrafluoroethylene
SCC	See IGSCC
SDR	Standard Design Ratio
SRSS	Square root sum of squares modal combination method
UHMWPE	Ultra-High Molecular Weight Polyethylene